

Product Guide



MARK OF CONFIDENCE



YOUR IDENTIFICATION AND PROCESSING SOLUTIONS SOURCE



Telesis is the leader in Product Identification and Processing Technologies. Our wide range of permanent, programmable, LASER, PINSTAMP® and TELESCRIBE® Marking Systems are fast and durable. They are relied on in thousands of manufacturing environments every day, throughout the world. ALL Telesis systems — whether standard or custom engineered —are backed by a global network of knowledgeable Sales and Service Professionals.

TELESIS LASER MARKING SYSTEMS

TELESIS offers a full line of laser marking systems capable of satisfying even the most demanding laser marking applications. Manufacturers of a wide range of products, from medical devices and instruments to automotive components, delicate plastics, ceramics, glass and airframe components, can mark virtually any material with text, bar codes, 2-D codes, logos and graphics. At the cutting edge of laser marking technology, Telesis now offers optional “mark-on-the-fly” capable versions of all of our standard laser systems.

Our E –Series diode-pumped, air-cooled lasers can operate in the harshest environments while maintaining peak performance for many thousands of hours of maintenance free operation. In addition, they offer superior beam characteristics that make them uniquely capable among near IR lasers for many difficult applications, such as marking high resolution graphics, fine text or 2D codes as well as marking many heat sensitive materials and components. The versatile E-Series, a broad family including seven different systems, features the powerful EV25, capable of high speed, high quality, deep engraving of virtually any non-organic material, as well as the EV4G green laser, the choice for many electronic components as well as a wide variety of plastics.

With our F-Series Fiber Lasers, we were the pioneer and continue to be the leader in Fiber Laser marking technology. These markers offer low maintenance marking of almost all metals at an affordable price. The F-Series includes two different models, with the 20W FQ20 for applications in which faster process speeds are required.

Our LY100 Lamp-Pumped LY100 is designed for high speed, deep to shallow marking on hard surfaces such as titanium and other high strength alloys, medical implants and hard plastics.

The CO-Series of CO2 lasers are ideal for making organic materials such as glass, plexiglass, plastics and acrylics, wood, leather, vinyl and rubber. With three power levels to choose from, the CO-series is led by the powerful 50W CO50.

Pattern design for any of our lasers is easy with the Telesis designed MERLIN® II LS Software. This extremely user-friendly software is based on the Windows® 2000, Windows® XP, and Windows Vista® platforms. Our AMI version of MERLIN® II LS addresses the need for a safe, easy operator interface. It provides the operator the capability to barcode scan to load patterns, load a picture of the part and fixture, and insert the marking data in the proper field all without the need of a keyboard – virtually mistake free.

Telesis offers full turnkey single source custom integrated or standard laser systems backed by our first-in-class service team and worldwide support by a network of representatives and distributors.





YOUR IDENTIFICATION AND PROCESSING SOLUTIONS SOURCE



Telesis is the leader in Product Identification and Processing Technologies. Our wide range of permanent, programmable, LASER, PINSTAMP® and TELESCRIBE® Marking Systems are fast and durable. They are relied on in thousands of manufacturing environments every day, throughout the world. ALL Telesis systems — whether standard or custom engineered —are backed by a global network of knowledgeable Sales and Service Professionals.

TELESIS LASER MARKING SYSTEMS

TELESIS offers a full line of laser marking systems capable of satisfying even the most demanding laser marking applications. Manufacturers of a wide range of products, from medical devices and instruments to automotive components, delicate plastics, ceramics, glass and airframe components, can mark virtually any material with text, bar codes, 2-D codes, logos and graphics. At the cutting edge of laser marking technology, Telesis now offers optional “mark-on-the-fly” capable versions of all of our standard laser systems.

Our E –Series diode-pumped, air-cooled lasers can operate in the harshest environments while maintaining peak performance for many thousands of hours of maintenance free operation. In addition, they offer superior beam characteristics that make them uniquely capable among near IR lasers for many difficult applications, such as marking high resolution graphics, fine text or 2D codes as well as marking many heat sensitive materials and components. The versatile E-Series, a broad family including seven different systems, features the powerful EV25, capable of high speed, high quality, deep engraving of virtually any non-organic material, as well as the EV4G green laser, the choice for many electronic components as well as a wide variety of plastics.

With our F-Series Fiber Lasers, we were the pioneer and continue to be the leader in Fiber Laser marking technology. These markers offer low maintenance marking of almost all metals at an affordable price. The F-Series includes two different models, with the 20W FQ20 for applications in which faster process speeds are required.

Our LY100 Lamp-Pumped LY100 is designed for high speed, deep to shallow marking on hard surfaces such as titanium and other high strength alloys, medical implants and hard plastics.

The CO-Series of CO2 lasers are ideal for making organic materials such as glass, plexiglass, plastics and acrylics, wood, leather, vinyl and rubber. With three power levels to choose from, the CO-series is led by the powerful 50W CO50.

Pattern design for any of our lasers is easy with the Telesis designed MERLIN® II LS Software. This extremely user-friendly software is based on the Windows® 2000, Windows® XP, and Windows Vista® platforms. Our AMI version of MERLIN® II LS addresses the need for a safe, easy operator interface. It provides the operator the capability to barcode scan to load patterns, load a picture of the part and fixture, and insert the marking data in the proper field all without the need of a keyboard – virtually mistake free.

Telesis offers full turnkey single source custom integrated or standard laser systems backed by our first-in-class service team and worldwide support by a network of representatives and distributors.





PIN MARKING SYSTEMS

Fully programmable **PINSTAMP**® Single and Multiple-Pin Marking Systems are based on Telesis' original, patented "Floating Pin" design. A pneumatically driven and returned metal pin permanently indents the marking surface with either dot matrix or continuous line characters — even logos, graphics or 2-D* Codes. Since the marking pin "floats" on constant return air pressure, surface irregularities up to ¼" are easily accommodated. And, no stress concentrations occur. Since the force of the mark is controlled by air pressure, product marking can be "customized" to suit most any application. Telesis manufactures over 10 versatile **PINSTAMP**® Models. They are cost-effective in a wide range of stand-alone or on-line manufacturing situations.

TELESCRIBE® Marking Systems inscribe high quality, continuous line characters in materials from plastics to hardened steel — in virtual silence. Other Pin Marking Systems include the **BENCHMARK**® Series of low cost markers for stand-alone, benchtop and hand-held applications, and **IDENTIPLATE**®, which provides efficient, automated tag marking for a variety of industrial or consumer products.

QUALITY - ISO9001

At Telesis, manufacturing management processes must comply with rigorous ISO Quality Standards. Product Testing in every phase of production ensures reliability throughout the life of your marking system.

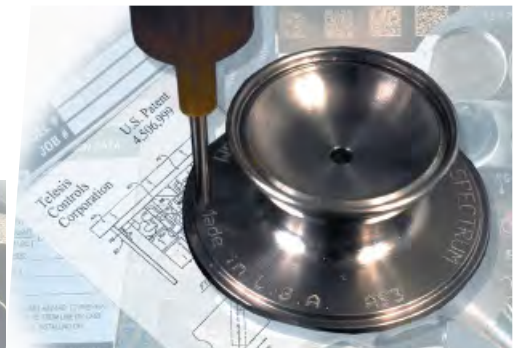
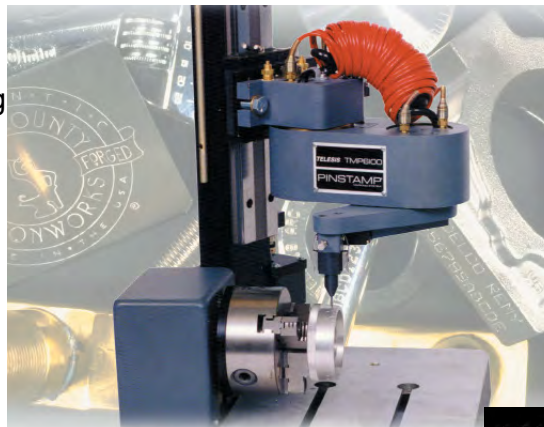

1K6PT37H0M6927828

CUSTOM ENGINEERED SOLUTIONS

Telesis is the leader in custom engineered/factory integrated marking technology. Whether it's a fully automated on-line application or a stand-alone manual workstation, Telesis Applications Engineers will work with you to solve your parts handling and custom software needs.

They can integrate any of our standard marking products within your specific application. You can expect a responsive, cost-effective, quality design solution to meet your unique requirements.



To learn more – or discuss a Custom Engineered Marking System, call 800.654.5696 TODAY – or visit us at www.telesis.com.

*Most Telesis Marking Systems are in compliance with the U.S. Department of Defense UID Requirements and ATA SPEC 2000 Aerospace Industry Standards for Data Matrix™ 2-D Code Parts Marking. Data Matrix™ is a registered trademark of Robotic Vision Systems, Inc.



All product descriptions subject to change without notice. Please refer to Product Specification Sheets or call the Applications Engineering Department at 800.654.5696 for current information.



TABLE of CONTENTS

Service and Support	Page 4
EV10, EV15 and EV25 Diode-Pumped Solid State Lasers	Page 5-7
Outstanding beam quality makes these lasers uniquely capable among near IR lasers for marking of high resolution graphics, fine text or 2-D codes.	
EY5 and EV7-SERIES Diode-Pumped Solid State Lasers	Pages 8-9
These Diode-Pumped, Solid State Laser Marking Systems are extremely reliable, low cost alternatives to other laser designs.	
EV4G Green Laser	Page 10
This fiber-coupled, diode-pumped, solid state, green wavelength laser marking system provides laser beam and Q-switched pulse characteristics optimized for applications that require high beam quality and stability.	
LY100 Lamp-Pumped Solid State Laser	Page 11
For the ultimate in high speed, high quality marking of hard surfaces and materials.	
F-SERIES FIBER LASERS — FQ10, FQ20 AND FQ20DH	Pages 12-13
Select the F-SERIES FQ10 for low to medium speed applications and the F-SERIES FQ20 when higher power/faster process speeds are required. The FQ20 features upgraded power, and both lasers offer the long-term safeguard of a built-in, optical isolator. The FQ20DH is a dual head version for extremely high throughput applications.	
CO-SERIES CO₂ Lasers	Page 14
Available in 10, 30, and 50 watt configurations, CO-Series CO ₂ Lasers are the choice for marking substrates like wood, glass, ceramics and fabrics.	
MERLIN® II LS Laser Software	Page 15
Designed to drive all core Telesis Laser Products. Simply highlight, click and mark!	
LASER MARKING SYSTEM SELECTION GUIDE	Pages 16-18
LASER MARKER ENCLOSURE, ACCESSORIES AND SYSTEM INTEGRATION	Page 19
Telesis offers a wide range of laser mark enclosures and other system accessories.	
TMP6100/470 PINSTAMP® Marking System	Page 20
The Single Pin TMP6100 is the most versatile PINSTAMP® Marking Head. It is easily integrated into either on or off-line applications. Since the marking pin can be positioned anywhere in the generous 6" x 12" (152 x 304mm) marking window, the TMP6100 can mark any character height or style, or number of lines desired. Its robotic design allows clear access to the marking window for loading and unloading of parts.	
TMC470 Marking System Controller	Page 21
The TMC470 is a truly state-of-the-art, compact, self-contained controller. Available with the TMP6100, TMP1700, TMP3200, TMM4250 and TMM4200 marking heads.	
MERLIN® III Visual Design Software	Page 21
Telesis' new WIN 32 Merlin® III Visual Design Software makes pattern design quick and intuitive. "WYSIWYG" (what you see is what you get) displays a to-scale image of the pattern as it's created. Just "click & drag" for immediate adjustments to field size, location or orientation.	
TMP1700/470 PINSTAMP® Marking System	Page 22
The TMP1700/470 is the lowest cost PINSTAMP® Marking System. The rugged Single Pin TMP1700 marking head features a compact, 1-1/2" x 2-1/2" (38.1 x 63.5mm) window, and marking speeds up to six characters per second. It's an excellent choice for many factory-automated or on-line processes. When combined with optional mounting post and base, the TMP1700 is cost-effective in off-line marking applications, too.	
TMP4210/420 PINSTAMP® Marking System	Page 23
The TMP4210/420 is an extremely lightweight, hand-held, single pin marker satisfying a wide range of portable marking applications. Its robust rack-and-pinion design and compact envelope also make it the right choice for many high production, on-line applications.	
TMP3200/470 PINSTAMP® Marking System	Page 24
The TMP3200/470 is a rugged, cost effective utility marker for on-line and off-line high speed marking applications. Its low-maintenance design features a 4" x 6" (100 x 150mm) marking window for multi-line text, and marking speeds up to six characters per second.	



TABLE of CONTENTS

TMC420 Marking System Controller	Page 25
The TMC420 is a versatile, compact system controller that can be used with most PINSTAMP® marking heads. The TMC420 is fully self-contained and requires no Personal Computer.	
TMM5400/420 PINSTAMP® Marking System	Page 26
With eight pins marking simultaneously, the TMM5400 is the fastest dot peen marker available. It can mark up to 16 characters per second in soft plastics or hardened steel. Choose from a variety of marking pins and cartridges to optimize window size and cycle time combinations.	
TMM4200/470 PINSTAMP® Marking System	Page 27
The unique TMM4200 Multiple Pin Marking Head can mark up to eight characters per second at depths to .013" (.33mm). Weighing 4.5 pounds, its compact, hand-tool like design with pistol-grip handle makes the TMM4200 the ultimate hand held permanent marker.	
TMM4215/420 PINSTAMP® Marking System	Page 28
Based on the TMM4200/420 design, the TMM4215/420 provides a marking window twice the size of the TMM4200/420.	
TMM4250/470 PINSTAMP® Marking System	Page 29
The TMM4250/470 Multiple Pin Marking System can mark up to eight characters per second. A NEMA 12 (IP55) enclosure with industrial grade, protective rubber "boot" makes it highly resistant to both solid and liquid contaminants. The TMM4250 features an extremely compact envelope. It can be integrated easily within a wide range of manufacturing settings.	
TMM5100/420 PINSTAMP® Marking System	Page 30
With up to six pins marking simultaneously, the TMM5100 Multiple Pin Marking system can mark up to six characters per second. Its lightweight, compact design and minimal footprint make it ideal for either automated or hand-held operations. A variety of pin cartridges are available for optimal character size/depth, cycle times and marking window areas.	
TMP7000 PINSTAMP® Marking System	Page 31
The TMP7000 is a powerful, heavy duty marking system for deep marking applications. This single pin marker is capable of marking characters up to .025" (.63mm) deep on mild steel.	
TMM7200 PINSTAMP® Marking System	Page 32
The TMM7200 is an extremely heavy duty marking system. It is the right choice for deep penetration marking of large characters. The flexible TMM7200 can be configured with up to 21 marking pins to print 21 characters in 1.5 seconds.	
SC3500/420 and SC5000/420 TeleScribe® Marking Systems	Page 33-34
For virtually silent marking, the economically priced SC3500/420 features a 4" x 6"(100 x 150mm) marking window. The powerful, heavy duty SC5000/420, with a 2.5" x 7.5" (63.5 x 190.5mm) marking window is particularly well suited for VIN marking applications.	
BenchMark®460 Hand-Held Marking System	Page 35
The BenchMark®460 is a fully programmable, cost effective alternative to old-fashioned permanent marking techniques for parts too large or heavy to be carried to a marking station.	
BenchMark®200 and 320 Benchtop Marking Systems	Page 36-37
These are extremely affordable benchtop markers equipped with an electromechanical marking pin.	
Pin Marker Product Accessories and System Intergration	Page 38
Choose from a variety of options and customized solutions to enhance your Telesis Marking System.	
2-D and UID Code Marking and Verification	Page 39
2-D and UID Code applications, where accurately marked codes are the key to readability.	
IMPACT PIN SELECTION GUIDE	Pages 40 – 41
PIN MARKING SYSTEM SELECTION GUIDE	Pages 42 – 43

All of our systems — standard and custom — are designed and built to your specifications at our 46,000 square foot (4087 square meter) facility located in Circleville, Ohio. We maintain state-of-the-art manufacturing tools for all of the mechanical, electrical and software functions needed to support your marking system. Telesis also maintains Sales and Distribution Offices in The Netherlands, Germany, England, and China.



Customer Service

At Telesis, Customers come First. Our Order Entry Specialists are fully trained to help with questions on pricing, product capabilities, accessories, spare parts and availability. They provide timely up-dates on the status of your order. Call us at **800-654-5696** for the answers!

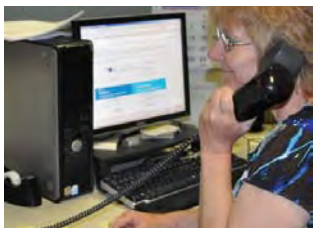

Technical Service

We back our customers with support and service for every system we build — world-wide. This includes on-site installation and start-up by our experienced Field Service Engineers. They'll even train your operating personnel — further assurance that your Telesis Marking System will perform dependably.

Have a technical question or concern? Telesis Service Technicians are available 24 hours a day — every day — to help you. Often, they can trouble-shoot and fix a problem over the phone, saving you time and money. Call our Technical Service Department at 800.867.8670 or e-mail a Telesis Service Technician at technical_services@telesistech.com.



Training

Telesis' commitment to customers is evident in our Training Facility. It features classroom-oriented and hands-on product training by experienced instructors. Our 3,000 square foot facility gives us the flexibility to easily accommodate up to 40 people in a classroom setting.



Smaller groups use product work-stations for a very effective, individual learning experience. On-site customized training for the customer can be also be developed as needed to meet the customers needs.

Our Warranty and Guarantee

Every Telesis Marking System carries a complete Parts and Service Warranty. During this time, we can ship replacement parts, free of charge, overnight in the continental United States. Plus, component exchange programs for reconditioned equipment can reduce downtime.



Extended Service warranties are available for all Telesis Marking Equipment. Contact your Telesis Representative or our Customer Service Department for details.

At Telesis, we're dedicated to support you for the life of your Marking System. We're with you 100% of the way.





E-SERIES EV25 Diode-Pumped Solid State Laser

The EV25 is the latest advancement in the Telesis E-series family of laser marking systems, offering 25W of power in a high quality laser beam. It is the solution to the most demanding marking application in automotive, medical, aerospace, and other commercial and industrial markets. The enhanced performance of the EV25 provides a solution for marking applications that require special characteristics such as deep marking, fast cycle times and high resolution marks.



The enhanced performance of the EV25 provides a solution for marking applications that require special characteristics such as deep marking, fast cycle times and high resolution marks.

LASER MARKER SPECIFICATIONS

Compliance.....	CDRH, CE
Wavelength.....	1064 nm
Laser Type.....	Fiber-coupled diode end-pumped, Q-switched Nd:YVO4 laser
Laser beam mode.....	TEM ₀₀
CW Power.....	25 Watts
Positioning.....	Visible Red Diode Light
Optical Fiber Length.....	1.75 meters (5.74 feet) standard 4.75 meters (15.58 feet) optional
Cooling.....	Air-cooled, active thermo-electric
Maxium Power Consumption.....	Less than 800 Watts
Operating Temperature Range.....	18° to 30° C (65° to 86° F)
Humidity.....	10% to 85% Non-condensing
Mounting Weight.....	Approx. 24 kg (53 lbs.)
Marketing Head Dimensions.....	66.3 (L) x 23.8 (W) x 21.3cm (H) (26.1" x 9.4" x 8.4")
Controller Dimensions.....	42 (W) x 14 (H) x 50cm (L) (16.5" x 5.5" x 19.5")



Engraved approximately 4mm deep in aluminum



Engraved approximately 2mm deep in aluminum



Features DATA MATRIX™ 2-D Code Marking Capability —
Meets all Department of Defense UID Requirements



E-SERIES EV25 Diode-Pumped Solid State Laser

At the heart of the EV25 marking system is our air cooled, high power, industrial grade 25W, diode-pumped, solid-state vanadate laser. It is designed to operate in the harshest of environments while maintaining peak performance for many thousands of hours of maintenance-free operation. When the time comes for maintenance and component replacement, most can be done onsite thanks to its modular design, eliminating the need to return the laser to the factory, resulting in lost revenue due to non-productive downtime.

The EV25 offers a broad range of laser performance that allows the user to tailor its operation for maximum results in the final mark. The EV25 offers distinct advantages over fiber lasers and other solid state lasers due to its superior beam quality, resulting in smaller focused spot sizes and a longer working depth of field than other lasers can offer. The key features of the EV25 provide the strength to tackle metals such as stainless steel, cobalt, and titanium, as well as provide the high marking speeds required for marking-on-the-fly (MOTF). It also provides the fine detail to do trimming, edge heat treating, and even marking delicate materials like plastics, foils, and labels. It produces superb annealed marks that stand up to the harshest of tests, high resolution 2D codes, and can even produce unique color marks on various metals. The EV25 can do all of this while providing customers with a quick return on investment as it meets their production requirements.



Model E9A Controller

LENS CONFIGURATION AVAILABLE

FOCAL LENGTH	MARKING FIELD
100mm	65mm X 65mm (2.56" X 2.56")
160mm	110mm X 110mm (4.33" X 4.33")
254mm	175mm X 175mm (6.88" X 6.88")
330mm	230mm X 230mm (9.06" X 9.06")
350mm	250mm X 250mm (9.84" X 9.84")
420mm	290mm X 290mm (11.42" X 11.42")

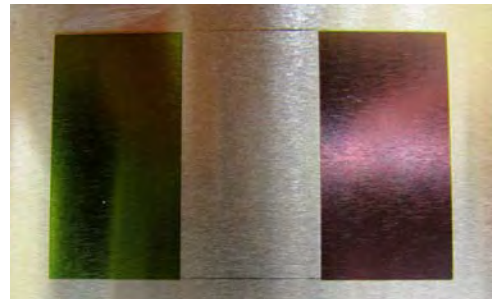

Color Marking on Stainless Steel

SOFTWARE

Software.....**MERLIN**® II LS (see page 15)
 Operating System.....Windows® 2000, Windows XP,
 or Windows Vista™
 Desktop PC (Std), Optional Laptop
 Communication Interface.....Serial, TCP/IP, I/O



Features DATA MATRIX™ 2-D Code Marking Capability —
 Meets all Department of Defense UID Requirements



E-SERIES EV10/EV15 Diode-Pumped Solid State Laser

The Telesis EV10 (10W) and EV15 (15W) markers are based on advanced Q-Switched, fiber-coupled diode end-pumped Nd: YVO4 lasers. The outstanding beam quality of the EV10 and EV15 makes them superior to all other markers of equivalent power for high resolution and high speed marking. Additionally, the shorter pulse widths and high peak powers of these markers make them the preferred choice for challenging marking applications on silicon or heat sensitive materials such as plastics or thin foils. Their smaller spot size and extended depth of focus allow the EV10 and EV15 to mark much more highly curved surfaces than fiber lasers. The air-cooled EV10 and EV15 are excellent choices for high speed Marking-On-the-Fly applications as well. With expected lifetime for the pump diode of over 20,000 hours, down time is dramatically reduced. Diode replacement can be completed quickly and the fiber coupled diode design eliminates the need to re-align the laser marker. The marker's modular design, housing the diode in the laser controller, eliminates a large heat source from the laser insuring maximum stability as well as the need for water cooling.



LASER MARKER SPECIFICATIONS

Compliance.....	CDRH, CE
Wavelength.....	1064 nm
Laser Type.....	Fiber-coupled diode end-pumped, Q-switched Nd:YVO4 laser
Laser beam mode.....	TEM ₀₀
CW Power.....	EV10 — 10W, EV15 — 15W
Positioning.....	Visible Red Diode Light
Optical Fiber Length.....	1.75 meters (5.74 feet) standard 4.75 meters (15.58 feet) optional
Cooling.....	Air-cooled, active thermo-electric
Operating Temperature Range.....	18° to 30° C (65° to 86° F)
Humidity.....	10% to 85% Non-condensing
Mounting Weight.....	Approx. 20 kg (45 lbs.)
Marketing Head Dimensions	
EV10.....	75.9 (L) x 17.7 (W) x 18.0cm (H) (29.9" x 7.0" x 7.1")
EV15.....	68.0 (L) x 16.2 (W) x 19.1cm (H) (26.8" x 6.4" x 7.5")
XPI Controller Dimensions.....	
	42 (W) x 14 (H) x 50 cm (L) (16.5" x 5.5" x 19.5")
Input Power (selectable).....	115/230 VAC 50/60 Hz
Max. Power Consumption.....	Less than 500W

LENS CONFIGURATIONS AVAILABLE

FOCAL LENGTH	MARKING FIELD
100mm	65mm X 65mm (2.56" X 2.56")
160mm	110mm X 110mm (4.33" X 4.33")
254mm	175mm X 175mm (6.88" X 6.88")
330mm	230mm X 230mm (9.06" X 9.06")
350mm	250mm X 250mm (9.84" X 9.84")
420mm	290mm X 290mm (11.42" X 11.42")

SOFTWARE

Software	MERLIN® II LS (see page 15)
Operating System.....	Windows® 2000, Windows XP, or Windows Vista™
Desktop PC (Std), Optional Laptop	
Communication Interface	Serial, TCP/IP, I/O



Features DATA MATRIX™ 2-D Code Marking Capability —
Meets all Department of Defense UID Requirements



MODEL XP1 SYSTEM CONTROLLER



E-SERIES EV7 Diode-Pumped Solid State Laser

The Telesis EV7 marker is based on an advanced Q-Switched, fiber-coupled diode end-pumped Nd: YVO₄ laser for applications requiring high beam quality and stability. Its exceptional power stability at all power levels makes the EV7 an ideal choice for high speed marking on delicate and heat sensitive electronic components, thin foils and medical instruments. The EV7 is completely air cooled with a very compact, easily integrated package requiring very little maintenance. With an expected lifetime for the pump diode of over 20,000 hours, down time is dramatically reduced. Because of the modular fiber coupled design, diode replacement can be completed quickly with no need to realign the laser.

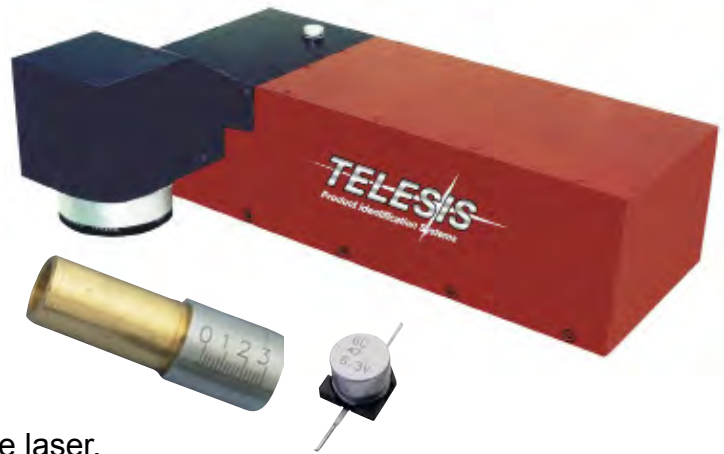

MODEL XP1 SYSTEM CONTROLLER

LASER MARKER SPECIFICATIONS

Compliance.....	CDRH, CE
Wavelength.....	1,064 nm
Laser Type.....	Fiber-coupled diode end-pumped, Q-switched Nd:YVO ₄ laser
Laser Beam Mode	TEM ₀₀
CW Power	7W
Positioning	Visible Red Diode Light
Optical Fiber Length	1.75 meters (5.74 feet) standard 4.75 meters (15.58 feet) optional
Cooling	Air Cooled, active thermo-electric
Operating Temperature Range	18° to 35°C (65° to 95° F)
Humidity.....	10% to 85% Non-condensing
Mounting Weight.....	approx. 13.6Kg (30 lb.)
Marking head dimensions.....	31.75 (W) x 15.72 (H) x 42.9cm (L) (12.5" x 6.187" x 16.885")
XP1 Controller diminsions.....	43 (W) x 14 (H) x 51cm (L) (17" x 5.5" x 20")
Input Power (selectable).....	115/230 VAC 50/60 Hz
Max. Power Consumption.....	Less than 500W

STANDARD LENS CONFIGURATION

FOCAL LENGTH	MARKING FIELD
100mm	65mm X 65mm (2.56" X 2.56")
160mm	110mm X 110mm (4.33" X 4.33")

Other lens configurations are available

SOFTWARE

Software	MERLIN® II LS (see page 15)
Operating System	Windows® 2000, Windows XP, or Windows Vista™
Desktop PC (Std), Optional Laptop	
Communication Interface	Serial, TCP/IP, I/O





E-SERIES EY5 Diode-Pumped Solid State Laser

The Telesis EY5 marker is based on an advanced Q-switched, fiber-coupled diode end-pumped Nd:YAG laser, which provides high pulse energies and exceptional beam quality for marking, scribing, trimming, and other material processing applications. The EY5 is a completely air cooled, very compact, easily integrated package requiring very little maintenance. With an expected lifetime for the pump diode of over 20,000 hours, down time is dramatically reduced. Because of the modular fiber coupled design, diode replacement can be completed quickly with no need to realign the laser. The EY5 is an extremely reliable, low cost alternative to other laser markers.



LASER MARKER SPECIFICATIONS

Compliance.....	CDRH, CE
Wavelength.....	1,064 nm
Laser Type.....	Fiber-coupled diode end-pumped, Q-switched Nd:YAG Laser
Mode.....	TEM ₀₀
CW Power	5W
Positioning	Visible Red Diode Light
Optical Fiber Length	1.75 meters (5.74 feet) standard 4.75 meters (15.58 feet) optional
Cooling	Air Cooled, active thermo-electric
Max. Power Consumption	Less than 500W
Operating Temperature Range	18° to 35° C (65° to 95° F)
Humidity.....	10% to 85% Non-condensing
Mounting Weight.....	approx. 13.6Kg (30 lb.)
Marking Head Dimensions	31.75 (W) x 15.72 (H) x 42.9cm (L) (12.5" x 6.187" x 16.885")
XP1 Controller Dimensions	43 (W) x 14 (H) x 51cm (L) (17" x 5.5" x 20")
Input Power (Selectable)	115/230 VAC, 50/60 Hz
Max. Power Consumption.....	Less than 500W

STANDARD LENS CONFIGURATION

FOCAL LENGTH	MARKING FIELD
100mm	65mm X 65mm (2.56" X 2.56")
160mm	110mm X 110mm (4.33" X 4.33")

Other lens configurations are available

SOFTWARE

Software.....	MERLIN ® II LS (see page 15)
Operating System	Windows® 2000, Windows XP, or Windows Vista™
Desktop PC (Std), Optional Laptop	
Communication Interface	Serial, I/O and Host Capable

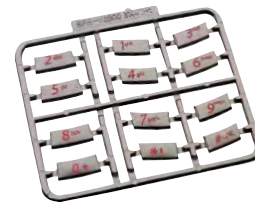

Features DATA MATRIX™ 2-D Code Marking Capability — Meets all Department of Defense UID Requirements



MODEL XP1 SYSTEM CONTROLLER



E-SERIES EV4G Green Laser

The EV4G marker is based on an advanced Q-switched, fiber-coupled, diode end-pumped and frequency doubled (green wavelength) Nd: YVO4 laser. Its laser beam and Q-switched pulse characteristics are optimized for applications that require high beam quality and stability. The 532nm wavelength of the EV4G offers extra power and speed for precision marking, scribing, trimming and other material processing that is not well suited for near IR or CO2 wavelength lasers. The robust mechanical and optical design of the EV4G enables operation in industrial environments where shock, vibration and dust are a concern. The EV4G is a completely air-cooled, very compact, easily integrated package requiring very little maintenance. With an expected life-time for the pump diode of over 20,000 hours, downtime is dramatically reduced. Because of the modular fiber coupled design, diode replacement can be completed quickly with no need to re-align the laser.



XP1 Laser Controller with temperature Controller

LASER MARKER SPECIFICATIONS

Compliance.....	CDRH, CE
Wavelength.....	532 nanometers (nm)
Laser Type.....	Fiber-coupled diode end-pumped, Q-switched Nd:YVO ₄ laser
Average Power (at 20KHZ).....	4W
Positioning.....	Visible Red Diode Light
Optical Fiber Length	1.75 meters (5.74 feet) standard 4.75 meters (15.58 feet) optional
Cooling	Air Cooled, active thermo-electric
Maximum Power Consumption.....	Less than 600 watts
Mounting Weight.....	approx. 25Kg (55 lbs.)
Operating Temperature Range.....	18° to 30°C (65° to 86° F)
Humidity.....	10% to 85% Non-condensing
Marking Head Dimensions	68.6 (L) x 24.5 (W) x 19.1cm (H) (26.99" x 9.658" x 7.524")
Temperature Controller Dimensions	21.3 (W) x 9.6 (H) x 21.2cm (D) (8.4" x 3.7" x 8.3")
XP1 Controller Dimensions	43 (W) x 14 (H) x 51cm (L) (17" x 5.5" x 20")
Input Power (selectable).....	115/230 VAC 50/60 Hz



LENS CONFIGURATIONS AVAILABLE

FOCAL LENGTH	MARKING FIELD
100mm	55mm X 55mm (2.17" X 2.17")
160mm	110mm X 110mm (4.33" X 4.33")
250mm	170mm X 170mm (6.69" X 6.69")

SOFTWARE

Software	MERLIN ® II LS (see page 15)
Operating System	Windows® 2000, Windows XP, or Windows Vista™
Desktop PC (Std), Optional Laptop	
Communication Interface	Serial, TCP/IP, I/O



Features DATA MATRIX™ 2-D Code Marking Capability —
Meets all Department of Defense UID Requirements



F-SERIES FQ10, FQ20 and FQ20DH Fiber Lasers

Innovative, compact and flexible F-SERIES Fiber Lasers are perfectly suited for marking applications that require 24/7 “set and forget”, unattended operation.

Select the 10W FQ10 for low to medium speed applications and the 20W FQ20 when higher power/faster process speeds are required. Both lasers offer the additional long-term safeguard of built-in, polarization/optical isolators.



Example — Laser marking on Coated Label Stock



LASER MARKER SPECIFICATIONS

Compliance	CDRH, CE, CSA
Wavelength	1070nm
Laser Type	Q-Switched Ytterbium Fiber Laser
Average Power FQ10.....	10 Watts
Average Power FQ20	20 Watts
Peak Power FQ10.....	>4KW
Peak Power FQ20.....	>8KW
Beam Quality	M ² < 2
Fiber Length FQ10.....	5 Meters (16 ft) Std.
Fiber Length FQ20.....	3 Meters (9.8 ft) Std.
Optical Isolator FQ10	Standard
Optical Isolator FQ20	Standard
Positioning	Visible Red Diode Light Input Power
Input Power Selectable.....	115VAC/230VAC, 50/60HZ
Cooling.....	Air Cooled, Fan/Filter (no water cooling required)
Operating Temperature Range.....	18° to 35° C Non-Condensing (65° F to 90° F)



Model 6 Controller



Customized Part Handling Options Available



Features DATA MATRIX™ 2-D Code Marking Capability — Meets all Department of Defense UID Requirements



F-SERIES FQ10, FQ20 and FQ20DH Fiber Lasers

Powered by 110/230VAC with no water-cooling requirements, these F-Series units are extremely dependable over a long life.

"All of your employees seem to be willing and able to give that "little bit extra" to make everything go right. The laser marking equipment you have supplied to us thus far has been totally reliable and continues to perform flawlessly, helping Federal-Mogul Corporation reduce costs as it continues to improve product quality. I look forward to a continued relationship with the people I consider my "friends" at Telesis Technologies."

Best Regards,
Ed Reinemeyer
Process Engineer,
Federal-Mogul Corporation



FQ10 Marking Head dimensions for 100mm lens.....	51.0(L) x 12.7 (W) x 14.0cm (H) (20.1" x 5.0" x 5.5")
FQ10 Mounting Weight.....	6.82 kg (15 lbs.)
FQ20 Marking Head Dimensions for 100mm lens.....	51.0(L) x 12.7 (W) x 14.0cm (H) (20.1" x 5.0" x 5.5")
FQ20 Mounting Weight.....	6.82 kg (15 lbs.)
Model 6 Controller Dimensions.....	42.5 (W) x 13.7 (H) x 50.8cm (D) (16.7" x 5.4" x 20.0")

LENS CONFIGURATIONS AVAILABLE

FOCAL LENGTH	MARKING FIELD
100mm	65mm X 65mm (2.56" X 2.56")
160mm	90mm X 90mm (3.54" X 3.54")
163mm	110mm X 110mm (4.33" X 4.33")
254mm	175mm X 175mm (6.89" X 6.89")
330mm	230mm X 230mm (9.06" X 9.06")
350mm	250mm X 250mm (9.84" X 9.84")
420mm	290mm X 290mm (11.42" X 11.42")

SOFTWARE

Software	MERLIN ® II LS (see page 15)
Operating System	Windows® 2000, Windows XP, or Windows Vista™
Desktop PC (Std), Optional Laptop	
Communication Interface	Serial, TCP/IP, I/O

The FQ20DH features an advanced, dual-scan marking head that is based on our successful Pulsed-Fiber Laser platform. Capable of extremely high-speed, high quality, simultaneous, duplicate marking on two surfaces, it offers lower operation costs along with increased production and handling efficiencies. In addition to marking, the FQ20DH is an excellent choice for scribing, trimming and a variety of material processing applications.





**CO-SERIES
CO2 Lasers**

The Telesis CO-Series Laser Markers, available in three different power levels, the 10W Model CP10, the 30W Model CO30 and the 50W Model CO50, are excellent choices for many plastic, anodized metal and label marking applications.

They are perfect for “Marking-on-the Fly” as well as stationary marking. Their RF-excited CO2 tube assures a long life cycle as well and virtually maintenance-free operation. Due to their compact size and modular construction, the CO-Series Markers can go almost any place they are needed on the plant floor.



Marking Head Weight.....	13.8 kg (30.4 lbs.)(10W)
	26.3 kg (58 lbs.)(30W)
	25.45 kg (56 lbs.)(50W)
CW Power CO10.....	10W
CW Power CO30.....	30W
CW Power CO50.....	50W
Controller Dimensions.....	49.28(W) x 20.07 (H) x 50.80cm (D)
	(19.4" x 7.9" x 20.0")
CO10.....	78.10(L) x 15.93 (W) x 20.65cm (H)
	(30.75" x 6.27" x 8.13")
CO30.....	97.35(L) x 14.71 (W) x 20.49cm (H)
	(38.33" x 5.79" x 8.07")
CO50.....	114.35(L) x 14.6 (W) x 20.78cm (H)
	(45.02" x 5.75" x 8.18")
Controller Weight.....	14.3 kg (31.5 lbs.)
Input Weight.....	100 – 240 VAC, 50 – 60Hz
Operating Temperature Range.....	16 – 35°C
	(61-95°F)

STANDARD LENS CONFIGURATIONS

FOCAL LENGTH	MARKING FIELD
75mm	50mm X 50mm (1.97" X 1.97")
100mm	70mm X 70mm (2.76" X 2.76")
150mm	100mm X 100mm (3.94" X 3.94")
200mm	140mm X 140mm (5.51" X 5.51")

Other lens configurations are available

MARKING SPEED

- Up to 152 m/minute (500 ft./minute) line speed for “Mark-on-the-fly” applications*
- 400 characters/second*

*Character marking speeds and production line speeds depend on material, character size and the desired marking quality.

SOFTWARE

Software.....	MERLIN® II LS (see page 15)
Operating System.....	Windows® 2000, Windows XP, or Windows Vista™
	Desktop PC (Std), Optional Laptop
Communication Interface.....	Serial, TCP/IP, I/O



Features DATA MATRIX™ 2-D Code Marking Capability —
Meets all Department of Defense UID Requirements

This powerful Merlin[®] II LS Visual Design Software is capable of driving any of the core Telesis Laser Products. Each system is shipped with a fully functioning version of the Software (on CD), that allows off-line program development.



Main Programming Screen

TELESIS LASER SOFTWARE FEATURES:

- Specially Designed by TELESIS – based on Windows[®] 2000, Windows XP, or Windows Vista[™]
- Import a wide range of Graphic Formats including DXF from AutoCAD[™], WINDOWS[®] Bitmaps, True Type Fonts as Vector or Raster Files
- Supports 4 Axis Movement (XYZ & Rotary)
- Highlight, click and mark!

COMPUTER REQUIREMENTS:

- Pentium[®] III 128 Mb RAM (minimum)
- Multi-gigabyte HDD
- Video, Sound Card
- CD-ROM and 3.5" Floppy Disk Drive
- SVGA Monitor, Mouse and Keyboard

OPTIONAL AMI VERSION:

Our AMI version of Merlin II LS addresses the need for a safe, easy operator interface that allows barcode scanning to load patterns, load a picture of the part and fixture, and insert the marking data in the proper field all without the need of a keyboard- virtually mistake free.

Raster Profile

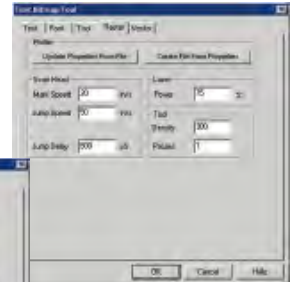

Bar Code Editor

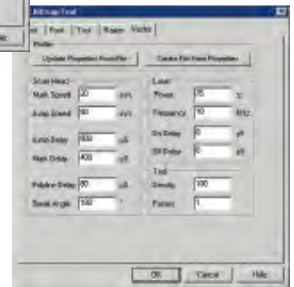

Vector Profile

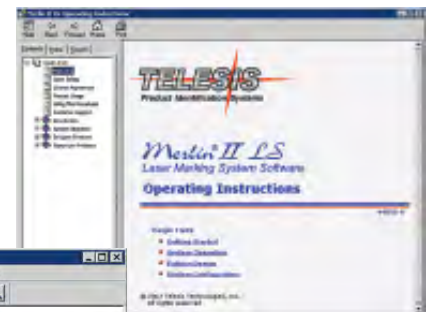

On Line Help

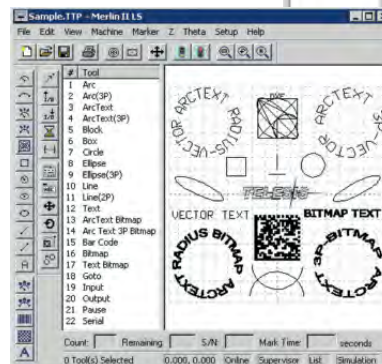

Window Overview



LASER MARKING SYSTEM SELECTION GUIDE

LASER SYSTEMS/ APPLICATIONS	FQ10	FQ20	FQ20DH	EY5
	1070nm wavelength, air-cooled, single phase, Q-switched, 10 Watt Yb fiber laser marker	1070nm wavelength, air-cooled, single phase, Q-switched, 20 Watt Yb fiber laser marker (Will provide shorter cycle times than FQ10.)	1070nm wavelength, air-cooled, single phase, Q-switched, dual scan head, 10 Watt per scanhead, Yb fiber laser marker	1064nm wavelength, air-cooled, single phase, diode end-pumped, Q-switched, 5 Watt Nd:YAG laser marker
Marking metals	Good choice for surface and deep marking of some metals. (Sensitive to back reflection. Not recommended for copper, brass or any other highly reflective or polished metals.)	Good choice for surface and deep marking of some metals. (Sensitive to back reflection. Not recommended for copper, brass or any other highly reflective or polished metals.)	Good choice for surface and deep marking of some metals. (Sensitive to back reflection. Not recommended for copper, brass or any other highly reflective or polished metals.)	Good choice for surface and deep marking all metals.
Marking plastics and label materials (3M, Tesa, etc.)	Good choice for marking many plastics and label materials. (Some surface melting can occur due to long pulse width.)	Good choice for marking many plastics and label materials. (Some surface melting can occur due to long pulse width.)	Good choice for marking many plastics and label materials. (Some surface melting can occur due to long pulse width.)	Good choice for marking plastics and label materials.
Marking silicon	Capable of deep marking of silicon.	Capable of deep marking of silicon.	Capable of deep marking of silicon.	Capable of deep marking of silicon.
Marking organic materials	Cannot mark wood. Can mark some other organic materials.	Cannot mark wood. Can mark some other organic materials.	Cannot mark wood. Can mark some other organic materials.	Cannot mark wood. Can mark some other organic materials.
Chemical marking	Can mark metals, glass and other materials using chemical marking.	Can mark metals, glass and other materials using chemical marking.	Can mark metals, glass and other materials using chemical marking.	Can mark metals, glass and other materials using chemical marking.
Marking high quality graphics	Can mark high quality graphics on some metals.	Can mark high quality graphics on some metals.	Can mark high quality graphics on some metals.	Excellent choice for marking high resolution graphics due to small spot size.
Workstation	Optional	Optional	Optional	Optional



LASER SYSTEMS/ APPLICATIONS	EV7	EV10	EV15	EV25
	1064nm wavelength, air-cooled, single phase, diode end-pumped, Q-switched, 7 Watt Nd:YVO4 laser marker	1064nm wavelength, air-cooled, single phase, diode end-pumped, Q-switched, 10 Watt Nd:YVO4 laser marker	1064nm wavelength, air-cooled, single phase, diode end-pumped, Q-switched, 15 Watt Nd:YVO4 laser marker	1064nm wavelength, air-cooled, single phase, diode end-pumped, Q-switched, 25 Watt Nd:YVO4 laser marker
Marking metals	Excellent choice for surface marking of almost every type of metal with very small heat effected zone.	Excellent choice for high speed surface marking of almost every type of metal with very small heat effected zone produced.	Excellent choice for high speed surface and deep marking of almost every type of metal.	Best choice for high speed surface and deep marking of almost every type of metal.
Marking plastics and label materials (3M, Tesa, etc.)	Good choice for marking plastics and label materials.	Excellent choice for marking plastics and label materials.	Excellent choice for high speed marking of plastics and label materials.	Excellent choice for high speed marking of plastics and label materials.
Marking silicon	Can do surface marking of silicon.	Good choice for surface and deep marking of silicon.	Excellent choice for deep marking of silicon.	Excellent choice for surface marking of silicon.
Marking organic materials	Cannot mark wood. Can mark some other organic materials.	Cannot mark wood. Can mark some other organic materials.	Cannot mark wood. Can mark some other organic materials.	Cannot mark wood. Can mark some other organic materials.
Chemical marking	Can mark metals, glass and other materials using chemical marking.	Can mark metals, glass and other materials using chemical marking.	Good choice for marking metals, glass and other materials using chemical marking.	Good choice for marking metals, glass and other materials using chemical marking.
Marking high quality graphics	Excellent choice for marking high resolution graphics due to small spot size.	Excellent choice for marking high resolution graphics due to small spot size.	Excellent choice for marking high resolution graphics due to small spot size.	Excellent choice for marking high resolution graphics due to small spot size.
Workstation	Optional	Optional	Optional	Optional





EV4G	LY100	CO10	CO30	CO50
532nm wavelength; air-cooled; single phase; diode end-pumped, Q-switched, 4 Watt green laser marker	1064nm wavelength, water-cooled, three phase, lamp pumped, Q-switched, 90W Nd:YAG laser marker	10,600nm wavelength, air-cooled, single phase, RF excited, 10W CO2 laser marker	10,600nm wavelength, air-cooled, single phase, RF excited, 30W CO2 laser marker (provides shorter cycle times than CO10)	10,600nm wavelength, air-cooled, single phase, RF excited, 50W CO2 laser marker (provides shorter cycle times than CO30)
Excellent choice for high speed surface marking all metals with very small heat effected zone produced.	Good choice for high speed surface and deep marking of almost all metals. Provides the shortest cycle times for deep marking.	Can mark some anodized metal surfaces.	Can mark anodized metal surfaces. With short focal length lenses, can mark some non-plated metal surfaces.	Can mark anodized metal surfaces. With short focal length lenses, can mark some non-plated metal surfaces.
Excellent choice for marking plastics. Marks largest variety of plastics.	Good choice for marking plastics and label materials.	Excellent choice for high speed marking of plastics and some label materials.	Excellent choice for high speed marking of plastics and some label materials.	Excellent choice for high speed marking plastics and some label materials.
Excellent choice for surface marking of silicon.	Can do deep marking and cutting of silicon.	Not recommended	Not recommended	Not recommended
Cannot mark wood. Can mark some other organic materials.	Cannot mark wood. Can mark some other organic materials.	Excellent choice for marking wood and other organic materials.	Excellent choice for marking wood and other organic materials.	Excellent choice for marking wood and other organic materials.
Cannot mark wood. Can mark some other organic materials.	Good choice for marking metals, glass and other materials using chemical marking	Good choice for marking metals, glass and other materials using chemical marking	Excellent choice for marking metals, glass and other materials using chemical marking.	Excellent choice for marking metals, glass and other materials using chemical marking.
Not recommended	Can mark high quality graphics on some metals.	Can mark high quality graphics on plastics and on some anodized metal surfaces.	Can mark high quality graphics on plastics and on some anodized metal surfaces.	Can mark high quality graphics on plastics and on some anodized metal surfaces.
Excellent choice for marking high resolution graphics due to small spot size. Highest	Optional	Optional	Optional	Optional



For all applications, it is highly recommended that samples be sent to Telesis for qualification and testing purposes.

Telesis offers a wide variety of standard Class 1 and Class 4 laser marker enclosure styles and sizes. When the situation demands it, our experienced custom engineering staff can design one to fit the specific needs of your application.

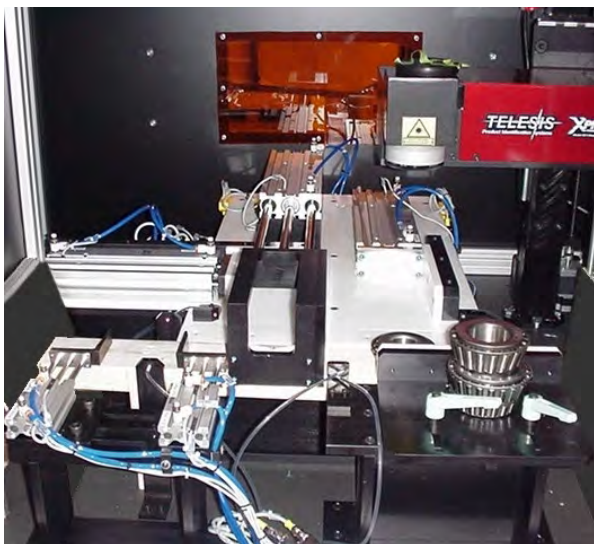
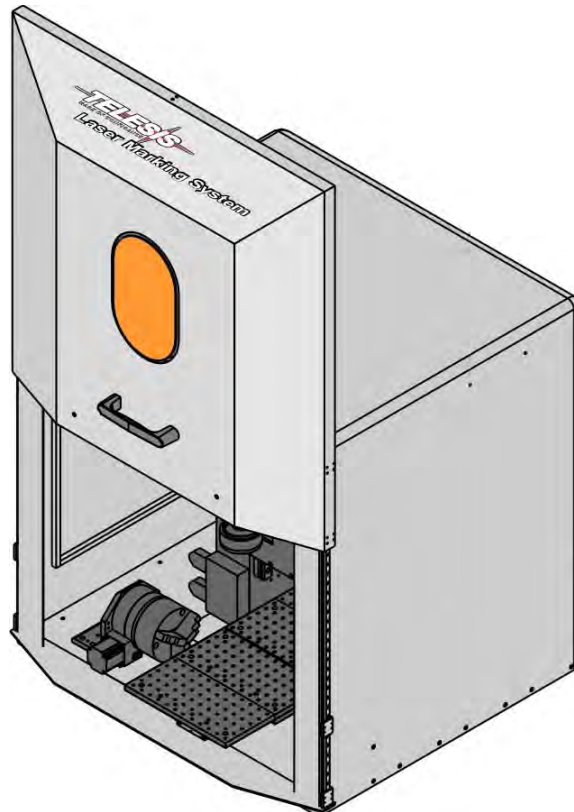

In addition, with parts handling accessories such as X/Y tables, rotary fixtures, rotary tables and manual and automated Z-axes, Telesis can provide a complete solution to your laser marking requirements.

The TMP6100 is the most versatile **PINSTAMP®** Marking Head. It is easily integrated into either on or off-line applications. Since the marking pin can be positioned anywhere in the generous 6" x 12" (152 x 304mm) marking window, the TMP6100 can mark any character height, style or number of lines desired. Its robotic design allows clear access to the marking window for loading and unloading of parts.

"The Telesis Model 6100/470 is a top quality product. They run 6 days a week, 10 hours a day, all day long, and they are 'bullet-proof'. I'd recommend the Telesis dot peen (Pinstamp) to anybody who needs that type of product marker. It is one of the best machines that we have."

Bud Nelson, Secondary Manager,
Acutec Precision Machining



FEATURES

- Large 6" x 12" (152 x 304mm) marking window
- Unique rigid positioning drive features robotic technology
- Marks a wide range of materials from soft plastics to hardened steel — up to Rc60
- Dot density up to 200 dots per inch (79 per centimeter)
- Choice of Interchangeable Marking Pin Types for depths from .001" – .018" (.02 – .45mm)
- Pin travel accommodates surface irregularities to .25" (6mm)
- Compact, self-contained TMC470 Controller with integral display and keyboard – no PC required (see page 21)
- RS232 or TCP/IP Host interface to download text to individual fields or call up entire patterns
- Automatically generates serial numbers, time, date and shift codes
- Easily interfaced to PLCs (Programmable Logic Controllers)
- Pattern backup via USB port
- Stores up to 200 marking patterns (files)

OPTIONAL ACCESSORIES

- Rotary fixtures for marking circumferences of cylindrical parts
- Marking head mounting posts, including programmable Z-axis version
- Logo/Font design Software Package for design of custom fonts or simple logos
- Powerful Windows-based **Merlin®** III software (See page 21)

Compact Self-Contained
TMC470 Controller



The TMP6100/470 contains Data Matrix® 2-D code marking capability, meeting all US Department of Defense UID requirements and other industry standards.

FEATURES

- Fully self-contained – no PC required
- Easy-to-use menu design for pattern design and access
- Ethernet port for TCP/IP communications
- Durable membrane keyboard
- Pattern backup via USB port
- Stores up to 200 marking patterns locally
- One RS232/485 and one RS232 serial port and discrete I/O capabilities with spare I/O available for customer-specific needs
- Optional internal board to control third and fourth axis (Z and rotary) – no separate driver required
- Optional panel-mount kit for panel mounting in NEMA/IP rated enclosures
- Conforms to all European Community (CE) norms
- Operates on 100 – 130 VAC or 200 – 250 VAC, 50 – 60 Hz power



Merlin® III

VISUAL DESIGN SOFTWARE

Offered as an optional accessory to a number of TMC470- based **Pinstamp®** Marking Systems, Telesis' powerful WIN 32 **Merlin®** III Visual Design Software with its state-of-the art graphical user interface, makes marking pattern design quick and easy.

"WYSIWYG" (what you see is what you get) interface provides a to-scale image of the pattern as it's created. Just "click & drag" for immediate adjustment to field size, location or orientation. Pattern Wizard Mode makes simple pattern design a snap even for the computer novice.

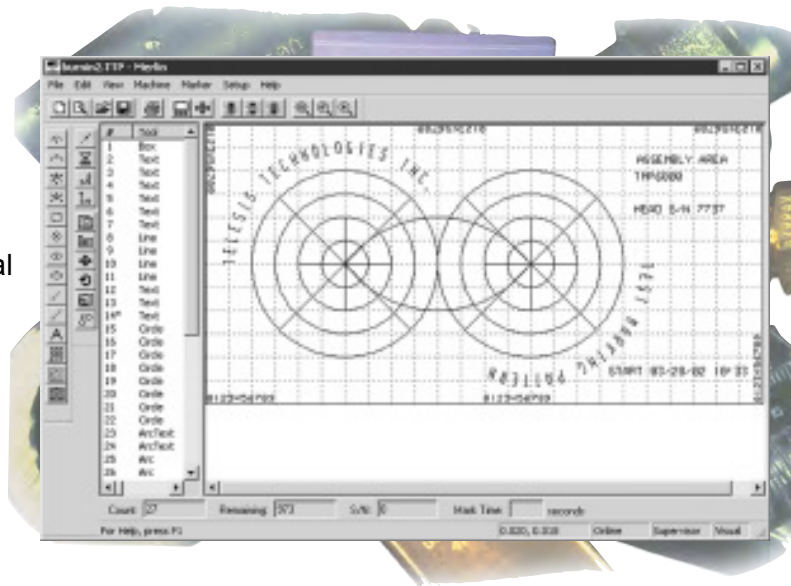

Marking "tools" available include text (at any angle), arc text, rectangles, circles, ellipses and lines. Multiple fields can be grouped and saved as a block to form a logo, or import logos via DXF CAD files.

Non-printable fields clearly show the graphical representation of the part being marked. Use the convenient, "GO TO" command to avoid obstacles within the marking window.

The TMP1700/470 is the lowest cost PINSTAMP® Marking System. The rugged TMP1700 marking head features a compact, 1-1/2" x 2-1/2" (38.1 x 63.5mm) window, and marking speeds up to six characters per second. It's an excellent choice for many factory-automated or on-line processes.

FEATURES

- 1-1/2" x 2-1/2" (38.1 x 63.5mm) Marking Window
- Rugged, low-maintenance X/Y platform
- Compact Marking Head — approximately 6.6" x 6.2" x 4.7" (168 x 158 x 120mm)
- Marks a wide range of materials from soft plastics to hardened steel — up to Rc60
- Shutter assembly protects marking head from solid and liquid contaminants
- Self-Contained, state-of-the-art TMC470 controller features two serial ports, USB port and ethernet port. (see page 21)
- Dot density up to 200 dots per inch (79 per centimeter)
- Choice of Interchangeable Marking Pin Types for depths from .001" - .018" (.03 - .45mm)
- Pin travel accommodates surface irregularities to .25" (6mm)
- Automatically generates serial numbers, time, date and shift codes
- Stores up to 200 marking patterns
- Easily interfaced to PLCs (Programmable Logic Controllers) and Host Computers

OPTIONAL ACCESSORIES

- Rotary fixtures for marking circumferences of cylindrical parts
- Marking head mounting post including programmable Z-axis version
- Panel-mount and IP/NEMA Rated Controllers
- Logo/Font design software package for design of custom fonts or logos
- PC-Based Upgrade Utility available FREE from www.telesis.com for easy software upgrade
- Powerful Windows based **Merlin® III** Software available third quarter 2009. (See page 21)

Compact Self-Contained TMC470 Controller



A protective shutter assembly shields the TMP1700 marking head from liquid and solid contaminants.



The TMP1700/420 contains Data Matrix® 2-D code marking capability, meeting all US Department of Defense UID requirements and other industry standards.

The TMP4210/420 is an extremely lightweight, hand-held, single pin marker satisfying a wide range of portable marking applications. Its robust rack-and-pinion design and compact envelope also make it the right choice for many high production, on-line applications.



FEATURES

- Simple, Easy to Use Single Pin Design
- Compact and Ergonomic; Weighs about 2.0kg (4.4 pounds)
- Available with 25S or 150SA Marking Pin
- 50 x 13mm (2" x .5") Marking Window
- Economically Priced
- Marks up to 3.5 mm (1/8") High Characters per Second
- Utilizes Same Rugged Rack-and-Pinion X/Y Platform as Field-Proven TMM4200
- Detachable Electronics Cable for Improved Serviceability
- Teamed with Reliable, Self-Contained TMC420 Controller (see page 25)
- Also Available Without Handle and Stand-Off for Fixtured Applications

OPTIONAL ACCESSORIES

- Panel-mount and IP/NEMA rated controllers
- Debris Shield Kit protects from solid contaminants
- Cable Balancer Attachment Bracket
- Marking Head Standoff V-Block kit for Marking the Circumference of Cylindrical Parts
- Quick Disconnect Tool Post
- Bar Code Scanner for automatic data entry
- Logo-Font design software package for design of custom fonts or logos
- PC-Based Upgrade Utility available FREE from www.telesis.com for easy software upgrade
- PC-Based Pattern (marking file) Back-up Utility available FREE from www.telesis.com



Compact TMC420 Controller features 4-line LCD Display — no PC required.



The TMP4210/420 contains Data Matrix® 2-D code marking capability, meeting all US Department of Defense UID requirements and other industry standards.

The TMP3200/470 Single Pin Marking System features a large 4" x 6" (100 x 150mm) marking window, and marking speeds up to six characters per second. Well suited for both bench top and factory-automated applications, its simple, yet robust belt-driven dual rail, X/Y platform yields high quality characters and low maintenance operation.



FEATURES

- 4" x 6" (100 x 150mm) Marking Window
- Belt-driven, dual rail X/Y mechanism with superior wear characteristics
- Patented floating pin technology accommodates surface irregularities of up to .25" (6mm)
- Marks a wide range of materials from soft plastics to hardened steel — up to Rc60
- Choice of pin sizes for marking depths from .001" - .018" (.03 - .45mm)
- Self-contained, state-of-the-art TMC470 controller features two serial ports, USB port and Ethernet port (see page 21)
- Automatically generates serial numbers, date, time and shift codes
- Stores up to 200 marking patterns
- Easily interfaced to PLCs (Programmable Logic Controllers) and Host Computers
- Dot density up to 200 dots per inch (79 per centimeter)

OPTIONAL ACCESSORIES

- Rotary fixtures for marking circumferences of cylindrical parts
- Marking head mounting post including programmable Z-axis version
- Panel-mount and IP/NEMA-Rated Controllers
- Logo/Font design software package for design of custom fonts or logos
- PC-Based Upgrade Utility available FREE from www.telesis.com for easy software upgrade
- Powerful Windows based Merlin® III software available third quarter 2009. (see page 21)



A protective shutter assembly shields the TMP3200 marking head from liquid and solid contaminants.



Compact Self-Contained TMC470 Controller



The TMP3200/470 contains Data Matrix® 2-D code marking capability, meeting all US Department of Defense UID requirements and other industry standards.

The TMC420 is a versatile, compact system controller that can be used with a wide range of Telesis Marking Heads. The TMC420 is fully self-contained and requires no Personal Computer. Other features include a 4-line LCD display and rugged rubber keyboard. With an RS232/485 serial port and eight discrete inputs/outputs, the TMC420 is easily integrated with factory automated applications.



The TMC420P is a panel-mount version designed specifically for mounting in industrial enclosures.



The TMC420N is a NEMA 12 (IP55) rated version for wall mounting or table top use.

FEATURES

- No PC required
- Three standard character fonts
- Automatic serialization, date coding and shift coding
- Four-line LCD display and rugged, sealed keyboard
- User-friendly pattern design software and prompted, interactive data entry
- Stores up to 75 marking patterns
- Extremely compact 12-1/2" W x 8" D x 2.8" H (317 x 203 x 71mm) envelope
- 12-24 VDC "Start Print," "Abort," "Ready" and "Done" I/O signals
- Up to 15 different marking patterns remotely selectable via 12-24 VDC discrete inputs
- RS232 Host/Scanner Interface to download text to individual fields or call up entire patterns
- Up to 31 controllers can be networked to a single host
- "Start Print" and "Abort Print" signals from a simple contact closure
- Operates on 100-130 VAC or 200-250 VAC, 50-60 Hz power
- Conforms to all European Community (CE) norms
- Flash memory and PC-based software utility provide for software upgrades without Eprom change
- Optional PC-based Logo-Font Design Software allows user-defined fonts or logos to be created in a PC, then downloaded to the TMC420
- Available with TMP3200, TMM4200, TMM4250, TMP4210, TMM4215, TMM5100, TMM5400, TMM7200, SC3500, and SC5000 Marking Heads.

Equipped with eight marking pins, the TMM5400/420 is the fastest dot peen marker available. Its speed and its compact envelope make it the perfect solution for many on-line, high-speed marking applications.

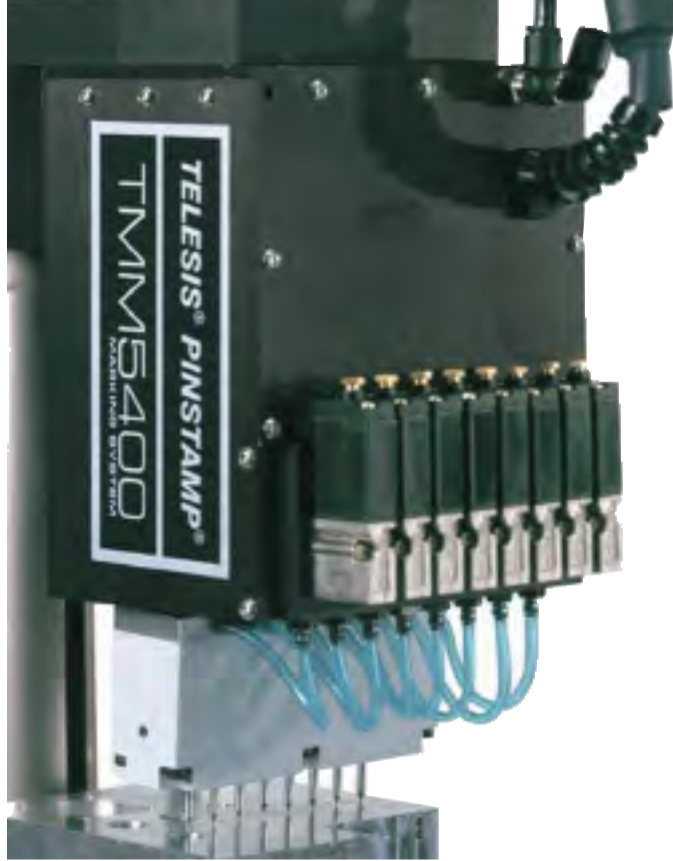

FEATURES

- Marks up to 16 Characters per Second
- Marking windows as large as .5" x 3.78" (13 x 96mm)
- Two marking pin cartridge configurations available to optimize marking window size/cycle time combinations
- Extremely compact marking head for easy integration into factory-automated applications
- Marks a wide range of materials from soft plastics to hardened steel — up to Rc60
- Telesis' patented "Floating Pin" technology accommodates surface irregularities up to .25" (6mm)
- Compact, convenient TMC420 Controller with rubber keyboard and 4-line LCD display — no PC required (see page 25)
- Automatically generates serial numbers, date, time and shift codes
- Easily interfaced to PLCs (Programmable Logic Controllers) and Host Computers
- Stores up to 75 marking patterns

OPTIONAL ACCESSORIES

- Panel-mount and IP/NEMA-Rated Controllers (see page 25)
- Logo/Font design software package for design of custom fonts or logos
- PC-Based Upgrade Utility available FREE from www.telesis.com for easy software upgrade
- PC-Based Pattern Back-up Utility available FREE from www.telesis.com



Compact TMC420 Controller features 4-line LCD Display — no PC required.



The TMM5400/420 contains Data Matrix® 2-D code marking capability, meeting all US Department of Defense UID requirements and other industry standards.

The unique TMM4200 Multiple Pin Marking Head can be equipped with up to four marking pins for very high speed marking, yet weighs only 4.5 pounds (2.0kg). Its light weight, compact ergonomic design, plus optional pistol-grip handle make the TMM4200 the ultimate hand-held permanent marker.

FEATURES

- Compact, Ergonomic Design
- Weighs 4.5 pounds (2.0kg)
- Available with four 25S or two 150SA Marking Pins
- Marks up to eight .125" (3mm) high Characters per Second
- Marking Windows up to 0.5" x 2" (13 x 50mm)
- Depths up to 0.013" (.33mm) in Mild Steel
- Rugged Rack-and-Pinion X/Y Platform for low maintenance operation
- Simple Shutter Plate Protects Head from Solid and Liquid Contaminants
- Detachable Electronics Cable for Improved Serviceability
- Self-contained, state-of-the-art TMC470 controller features two serial ports, USB port and Ethernet port (see page 21)
- Also Available Without Handle and Stand-Off for Fixtured Applications
- Automatically generates serial numbers, date, time and shift codes
- Stores up to 200 Marking Patterns
- Easily interfaced to PLCs (Programmable Logic Controllers) and Host Computers



OPTIONAL ACCESSORIES

- Panel-mount and IP/NEMA-Rated Controllers (see page 21)
- Quick Disconnect Tool Post
- Logo/Font design software package for design of custom fonts or logos
- PC-Based Upgrade Utility available FREE from www.telesis.com for easy software upgrade

Compact Self-Contained TMC470 Controller



The TMM4200/470 contains Data Matrix® 2-D code marking capability, meeting all US Department of Defense UID requirements and other industry standards.

The innovative dual-pin TMM4215 provides a 4" x 0.5" (100 x 13mm) marking window, twice as large as that of the TMM4200. This lightweight, compact marker is available in both fixtured and hand-held configurations.

FEATURES

- Compact, ergonomic design
- Weighs 4.5 pounds (2.0kg)
- Marks up to four .125" (3mm) high characters per second
- Available with the high-speed 25S marking pin or the deep marking 150SA pin
- Marking depths up to 0.013"(.33mm) in Mild Steel
- Rugged Rack and Pinion X/Y Platform for low maintenance operation
- Also available without handle and standoff for fixtured applications
- Detachable Electronics cable for improved serviceability
- Compact, convenient TMC420 controller with rubber keyboard and 4-line LCD display - no PC required (see page 25)
- Automatically generates serial number, time, date and shift codes
- Stores up to 75 marking patterns
- Easily interfaced to PLC's (Programmable Logic Controllers) and host computers

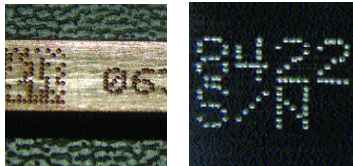

OPTIONAL ACCESSORIES

- Panel-mount and IP/NEMA rated controllers (see page 25)
- Cable balancer attachment kit
- Marking head standoff V-Block Kit for marking on the circumference of cylindrical parts
- Quick-disconnect tool post
- Bar code scanner for automatic data entry
- Logo-Font Design Software package for design of custom fonts or logos
- PC-based upgrade utility available FREE from www.telesis.com for easy software upgrade
- PC-based Pattern (marking file) Back-up utility available FREE from www.telesis.com

Shown with optional debris shield



The TMM4215/420 contains Data Matrix® 2-D code marking capability, meeting all US Department of Defense UID requirements and other industry standards.

The TMM4250/470 Multiple Pin Marking System can mark up to eight characters per second. It is ideal for many on-line applications with severe spatial constraints — or in wet or dirty environments. The TMM4250 Marking Head features an extremely compact envelope and provides marking windows up to 0.5" x 2" (13 x 50mm). It can be easily integrated within a wide range of manufacturing settings. A NEMA 12 (IP55) enclosure with industrial grade, protective rubber “boot” makes it highly resistant to both solid and liquid contaminants, including machine tool coolants.



OPTIONAL ACCESSORIES

- Panel-mount and IP/NEMA-Rated Controllers
- Logo/Font design software package for design of custom fonts or logos
- PC-Based Upgrade Utility available FREE from www.telesis.com for easy software upgrade
- PC-Based Pattern Back-up Utility available FREE from www.telesis.com



FEATURES

- NEMA 12-Rated (IP55) with Rubber Boot for Protection Against Solid and Liquid Contaminants
- Extremely Compact for Ease of Integration
- Available with four 25S or two 150SA Marking Pins
- Marks up to eight .125" (3mm) high Characters per Second
- Self-contained, state-of-the-art TMC470 controller features two serial ports, USB port and Ethernet port (see page 21)
- Stores up to 200 marking patterns
- Marking Windows up to 0.5" x 2" (13 x 50mm)
- Depths up to 0.013" (.33mm) in Mild Steel
- Rugged Rack-and-Pinion X/Y Platform for low maintenance operation
- Detachable Electronics Cable for Improved Serviceability
- RS232 or TCPIP Host interface to download text to individual fields or call up entire patterns
- Automatically generates serial numbers, date, time and shift codes
- Easily interfaced to PLCs (Programmable Logic Controllers) and Host Computers

Compact Self-Contained TMC470 Controller



The TMM4250/470 contains Data Matrix® 2-D code marking capability, meeting all US Department of Defense UID requirements and other industry standards.

Mark up to six characters/second with the TMM5100/420 Multiple Pin Marking System. Its lightweight, compact design and minimal footprint are ideal for hand-held, stand-alone or completely integrated, factory automated operations. A variety of pin sizes/configurations are available to mark character heights from .04" - .63" (1 - 16mm) on a wide range of materials.



FEATURES

- High speed — up to six pins marking simultaneously
- Marking windows up to .625" x 4.5" (16 x 114mm)
- Marks a wide range of materials from soft plastics to hardened steel — up to Rc60
- Available with a variety of marking pin cartridge configurations for optimal combination of character size, marking depth, marking window size and cycle time
- Compact, rugged X/Y positioning mechanism
- The right choice for many VIN (Vehicle Identification Number) Marking Applications
- Compact, convenient TMC420 Controller with rubber keyboard and 4-line LCD display — no PC required (see page 25)
- Automatically generates serial numbers, time, date and shift codes
- Stores up to 75 marking patterns
- Easily interfaced to PLCs (Programmable Logic Controllers) and Host Computers
- Pin travel accommodates surface irregularities to .25" (6mm)

OPTIONAL ACCESSORIES

- Panel-mount and IP/NEMA-Rated Controllers (see page 25)
- Marking head support tooling and balancers
- Logo/Font design software package for design of custom fonts or logos
- PC-Based Upgrade Utility available FREE from www.telesis.com for easy software upgrade
- PC-Based Pattern Back-up Utility available FREE from www.telesis.com



Compact TMC420 Controller features 4-line LCD Display — no PC required.



The TMP7000/420 is a robust single pin marker targeted at applications requiring extremely deep penetration marking. Its 4" x 6" (100 x 150mm) marking window is ample for a wide range of applications and its TMC420 controller allows it to be easily integrated into most automated applications.



"We recommend Telesis hardware to our clients because we believe it is the best marking equipment available. The success of our software business depends on high quality 2D Data Matrix™ dot peen marks and Telesis consistently delivers quality marks – every day – every time!"

Chuck Stewart, Stewart Technologies Inc.

FEATURES

- Great for marking large characters and/or rough surfaces
- Large 4" x 6" (100 x 150mm) marking window
- Marks up to 0.025" (.63mm) deep in mild steel
- Compact, convenient TMC420 Controller with rubber keyboard and 4-line LCD display — no PC required (see page 25)
- Automatically generates serial numbers, date, time and shift codes
- Marks a wide range of materials from soft plastics up to hardened steel
- Stores up to 75 marking patterns

OPTIONAL ACCESSORIES

- Panel-mount and IP/NEMA-Rated Controllers (see page 25)
- Marking head support tooling and balancers
- Logo/Font design software package for design of custom fonts or logos
- PC-Based Upgrade Utility available FREE from www.telesis.com for easy software upgrade
- PC-Based Pattern Back-up Utility available FREE from www.telesis.com



Compact TMC420 Controller features 4-line LCD Display — no PC required.



The TMM4250/420 contains Data Matrix® 2-D code marking capability, meeting all US Department of Defense UID requirements and other industry standards.

The TMM7200 is an extremely heavy duty multiple pin marking system configured on a “per project” basis to provide optimum solutions for individual applications. The TMM7200 is the right choice for the deep penetration marking required for large character sizes, or when marking especially rough surfaces. The flexible TMM7200 can be equipped with up to 21 marking pins, allowing it to print 21 characters in 1.5 seconds. In addition, marking pins can be located on varying horizontal and vertical center distances from .25” (6mm) to 1.75” (44.5mm) to provide a wide range of very large marking windows.

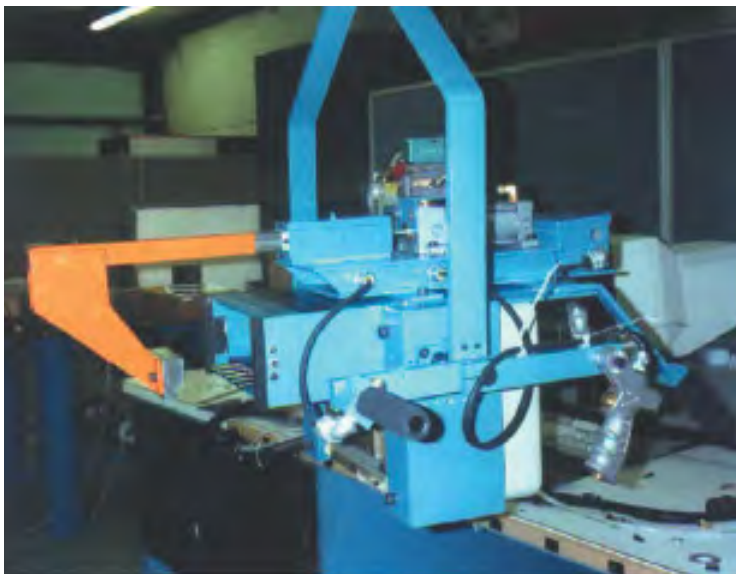
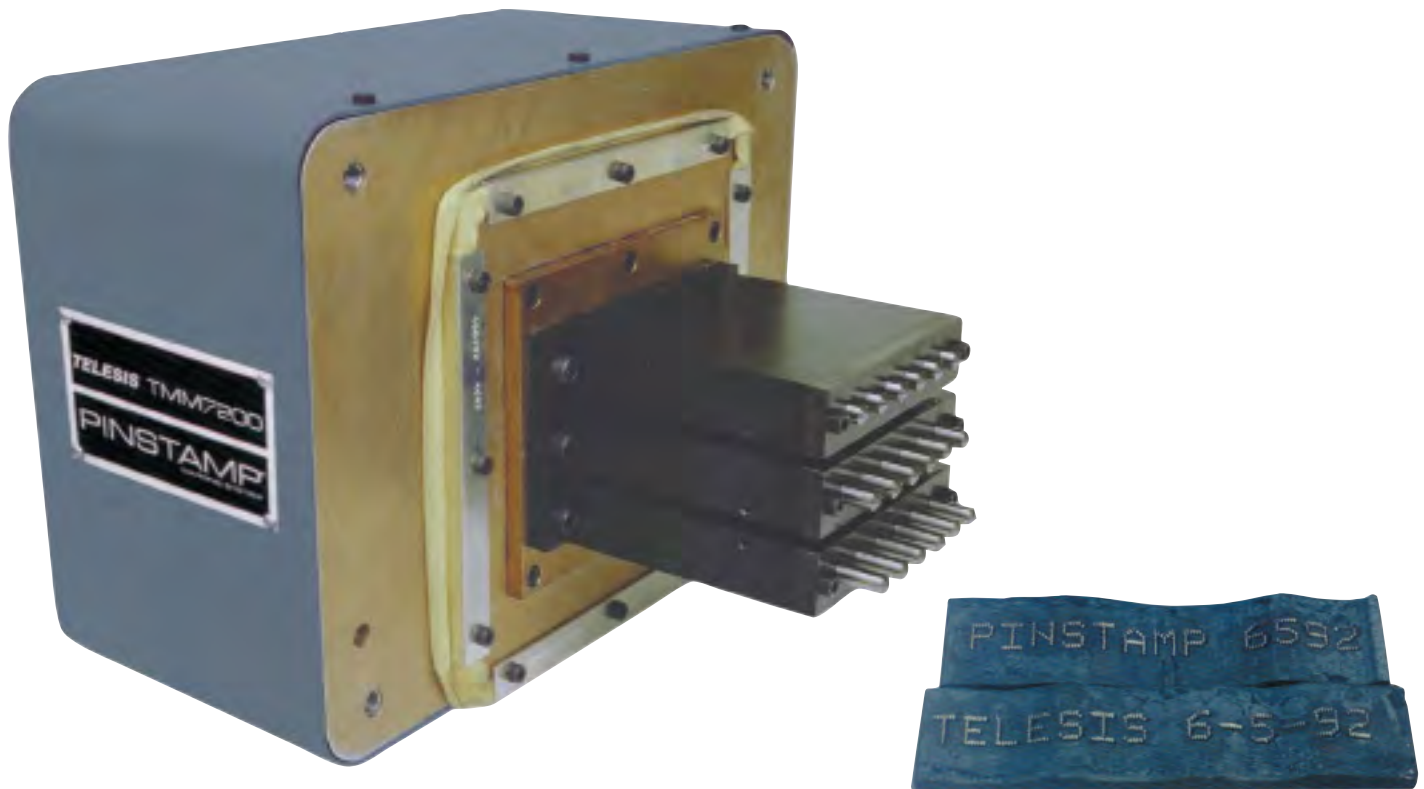

The TMM7200 is easily adapted to custom designs and fixturing options.

PINSTAMP® MARKING

Virtually silent, the economical SC3500/420 inscribes high quality, continuous line characters in most metals and plastics. It is well suited for a wide range of automated on-line and stand-alone bench top applications.



FEATURES

- Extremely low noise marking
- Durable, heavy duty marking head provides large 4" x 6" (100 x 150mm) marking window
- Economically priced Scribe Marker, well suited for a wide range of automated on-line and stand-alone Bench Top applications
- Compact, convenient TMC420 Controller with rubber keyboard and 4-line LCD display — no PC required (see page 25)
- Automatically generates serial numbers, date, time and shift codes
- Easily interfaced to PLCs (Programmable Logic Controllers) and Host Computers
- Marks a wide range of materials from soft plastics up to hardened steel
- Stores up to 75 marking patterns

OPTIONAL ACCESSORIES

- Marking head mounting post with base
- Panel-mount and IP/NEMA-Rated Controllers (see page 25)
- Marking head support tooling and balancers
- Logo/Font design software package for design of custom fonts or logos
- PC-Based Upgrade Utility available FREE from www.telesis.com for easy software upgrade
- PC-Based Pattern Back-up Utility available FREE from www.telesis.com



Compact TMC420 Controller features 4-line LCD Display — no PC required.



The powerful, extremely heavy-duty SC5000/420 is the right choice when deep, low noise marking is required. It is especially well-suited for VIN (Vehicle Identification Number) marking applications.



FEATURES

- Extremely low noise marking
- Powerful, rugged marking head drive mechanism for deep scribe marking
- 2½" x 7½" (63.5 x 190.5mm) marking window
- Especially well suited for VIN (Vehicle Identification Number) applications
- Compact, convenient TMC420 Controller with rubber keyboard and 4-line LCD display — no PC required (see page 25)
- Automatically generates serial numbers, date, time and shift codes



- Easily interfaced to PLCs (Programmable Logic Controllers) and Host Computers
- Marks a wide range of materials from soft plastics up to hardened steel
- Stores up to 75 marking patterns

OPTIONAL ACCESSORIES

- Marking head support tooling and balancers
- Panel-mount and IP/NEMA-Rated Controllers (see page 25)
- Logo/Font design software package for design of custom fonts or logos
- PC-Based Upgrade Utility available FREE from www.telesis.com for easy software upgrade
- PC-Based Pattern Back-up Utility available FREE from www.telesis.com
- Optional SS5500/420 Servo Motor Driven Versions Available For High Speed Applications

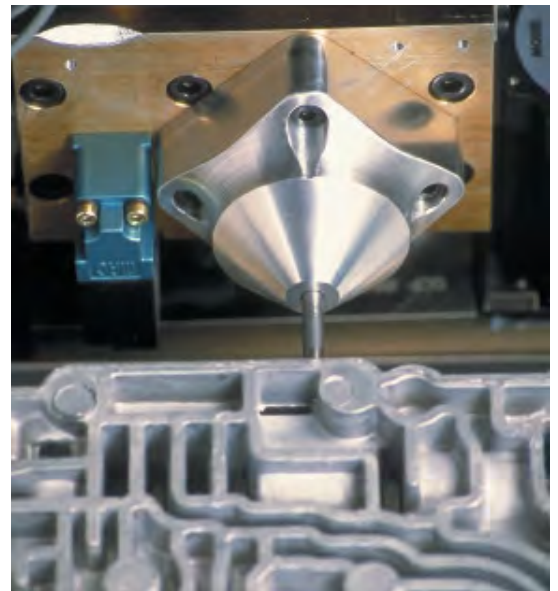

Compact TMC420 Controller
features 4-line LCD Display — no PC required.

The **BenchMark® 460** is a fully programmable, cost effective alternative to old-fashioned permanent marking techniques for parts too large or heavy to be carried to a marking station. Its hand-held marking head is lightweight and ergonomically designed, while providing a generous 25 x 100mm (1" x 4") marking window. An electromechanical marking pin eliminates the need for any air supply, making the **BenchMark® 460** truly portable.



FEATURES

- Compact, ergonomic marking head weighs only 1.7 kg (3.75 pounds)
- Generous 25 x 100mm (1" x 4") marking window
- High quality, permanent, programmable marking on a wide range of materials — from soft plastics to hard metals up to Rc60
- No consumables
- Electromechanical marking pin eliminates the need for air supply
- Marks up to 5 characters per second
- Automatically generates serial numbers, as well as date, time and shift codes



OPTIONAL ACCESSORIES

- Bar Code Scanner for automatic data entry
- Logo-Font design software package for design of custom fonts or logos
- PC-Based Upgrade Utility available FREE from www.telesis.com for easy software upgrade
- PC-Based Pattern (marking file) Back-up Utility available FREE from www.telesis.com



Compact, BenchMark® Controller with rubber keyboard features 4-line LCD Display — no PC required

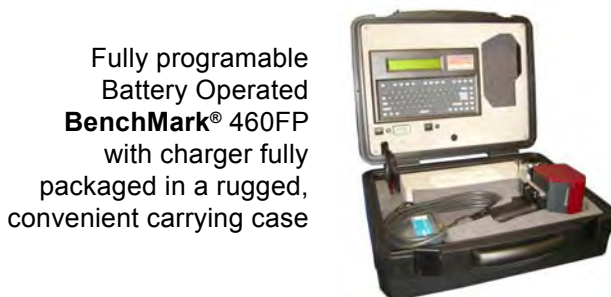

Fully programable
Battery Operated
BenchMark® 460FP
with charger fully
packaged in a rugged,
convenient carrying case



Features DATA MATRIX™ 2-D Code Marking Capability — Meets all Department of Defense UID Requirements

The **BenchMark**® 320 is an extremely versatile yet economically priced benchtop marking system. It offers a generous 4" x 6" (100 x 150mm) marking window large enough to satisfy almost any application. And its unique marking arm design is extremely convenient for parts loading and unloading as well as marking pattern design. The system is self-contained with compact controller and rugged extruded aluminum mounting post and base.

"I want to thank Telesis for manufacturing a product that performs as well in real life as it states in your literature.

Our new **BenchMark**® 320 Marking System from Telesis has performed above our expectations since putting it into service. The **BenchMark**® 320 greatly simplified our identification tag printing process and provided Krispy Kreme with "just in time" tag production capabilities. If you are looking for high quality, flexibility and reliability in permanent marking equipment, Telesis has the solution."

Jeff Renz, Krispy Kreme



FEATURES

- High quality, permanent, programmable marking on a wide range of materials — from soft plastics to hard metals up to Rc60
- Large 4" x 6" (100 x 150mm) marking window
- Marking arm allows clear access for loading and unloading of parts
- Electromechanical marking pin eliminates the need for air supply
- Marks up to 5 characters per second
- Automatically generates serial numbers, as well as date, time and shift codes
- Compact, convenient controller with 4-line LCD display and rubber keyboard- no PC required

OPTIONAL ACCESSORIES

- Rotary fixture for marking circumferences of cylindrical parts
- Bar Code Scanner for automatic data entry
- Start-Print footswitch and pushbutton station
- Logo/Font design software package for design of custom fonts or logos
- PC-Based Upgrade Utility available FREE from www.telesis.com for easy software upgrade
- PC-Based Pattern Back-up Utility available FREE from www.telesis.com
- **Benchmark**® 320+ version with enhanced communications capabilities



Features DATA MATRIX™ 2-D Code Marking Capability — Meets all Department of Defense UID Requirements

The **BenchMark® 200** is an extremely economical, fully programmable alternative to old-fashioned permanent marking techniques. This complete system, with self-contained controller and extruded aluminum marking head mounting post and base, is the right choice for many stand-alone bench top marking applications. An electromechanical marking pin eliminates the need for any air supply, making it easy to move the **BenchMark® 200** from one work area to another.



FEATURES

- Extremely affordable
- High quality, permanent, programmable marking on a wide range of materials — from soft plastics to hard metals up to Rc60
- Ample 4" x 4" (100 x 100mm) marking window
- Electromechanical marking pin eliminates the need for air supply
- Marks up to 5 characters per second
- Automatically generates serial numbers, as well as date, time and shift codes
- Compact, convenient controller with rubber keyboard and 4-line LCD display — no PC required

OPTIONAL ACCESSORIES

- Rotary fixture for marking circumferences of cylindrical parts
- Bar Code Scanner for automatic data entry
- Start-Print footswitch and pushbutton station
- Logo/Font design software package for design of custom fonts or logos
- PC-Based Upgrade Utility available FREE from www.telesis.com for easy software upgrade
- PC-Based Pattern Back-up Utility available FREE from www.telesis.com
- **Benchmark® 200+** version with enhanced communications capabilities

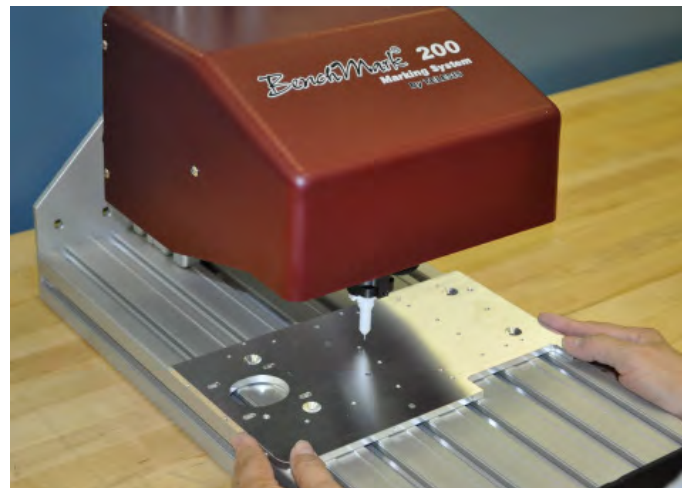

Features DATA MATRIX™ 2-D Code Marking Capability — Meets all Department of Defense UID Requirements

Choose from a variety of accessories to enhance your Telesis Pin Marking System. All are tested for compatibility and carry a one-year limited warranty. Ask your Telesis Sales Representative about the options best suited for your application.

Rotary Fixtures

For easy circumferential marking

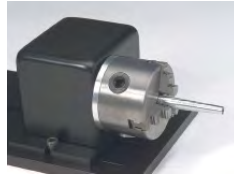

Marking Head Gimbals, Stand-offs and Cable Balancers

For flexible, virtually weightless, hand-held marking



Bar Code Scanners and Wands

Eliminate manual data entry

Manual Push Button Stations and Foot Switches

For manual control of on-line automated marking stations and remote start control



A variety of Industrial Controller Enclosures are Available

Protect control components from harsh environments. Several wall and floor-mount styles/ colors available



Four Wheeled Carts

For portable applications



Marking Head Mounting Posts

With manual, pneumatic or stepper motor-driven head positioning mechanisms



In addition, Telesis offers expert integration of our entire range of pin marking systems, including software, hardware and control system design services. Whether it's a stand-alone manual marking station or a fully automated on-line factory-integrated application, Telesis can provide a complete solution to your marking system requirements.



Manufacturers are increasingly turning to the use of 2-D code direct part marking (DPM) and reading technologies. DPM reduces costs, improves quality, and satisfies a number of industry-specific and government mandates, including U.S. Department of Defense UID (Universal Identification) requirements. Successful implementation requires the integration of robust, industrial marking systems with 2-D code verifiers located at the marking station. Together, they insure the ability to easily read and track the 2-D code.

Telesis' extensive experience in the automotive, aerospace and firearms industries makes us uniquely qualified to provide, completely integrated, "mark-read" solutions. We offer the following products and services to satisfy a wide range of 2-D code applications:

- Telesis' PINSTAMP® Dot Peen Marking Systems
- Telesis' Laser Marking Systems
- Expert integration of these Telesis products, as well as the integration of 2-D code verifiers marketed by a number of suppliers

PINSTAMP® Markers provide an effective but extremely economical solution to many 2-D code DPM applications on materials as diverse as plastics and hardened steel. Telesis' patented **PINSTAMP®** Marking Technology provides highly accurate dot placement at specific X/Y locations. This process makes PINSTAMP® Markers far superior to conventional "oscillating stylus" dot peen markers, especially in 2-D code applications, where accurately marked codes are the key to readability.

TELESIS Lasers are truly "state-of-the-art", producing almost perfectly formed 2-D codes nearly instantly on a wide range of materials, including virtually all plastics and metals. These qualities make lasers the perfect choice for applications requiring extremely high throughput or very small 2-D codes.

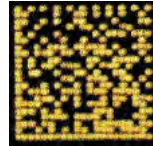

COMPLIANCE

All TELESIS LASERS and all PINSTAMP® Markers except for the TMM5100/420 and TMM7200 comply with all major 2-D code DPM standards, including:

- SAE AS9132 (as adopted by the International Aerospace Quality Group)
- AIAG B-4
- AIAG B-17
- NASA-STD-6002
- NASA-STD-HDBK-6003
- Department of Defense Guide to Uniquely Identifying Items (UID)
- MIL-STD-130N

PIN STYLE	CONE ANGLES	MATERIALS*	LENGTH	MAJOR DIAMETER	MINOR DIAMETER
10MP	30° 45°	Carbide	0.62" 16mm	0.09" 2.3mm	0.04" 1.0mm
25S	22° 30° 45° 60°	Carbide, Powdered Metal	1.8" 45mm	0.19" 4.8mm	0.09" 2.4mm
25L	22.5° 30° 45° 60°	Carbide, Powdered Metal	2.2" 55mm	0.19" 4.7mm	0.09" 2.4mm
25XL	22.5° 30° 45° 60°	Carbide, Powdered Metal	2.5" 64mm	0.19" 4.7mm	0.09" 2.4mm
25XLE	30° 45°	Carbide	1.8" 46mm	0.16" 4.0mm	0.09" 2.4mm
101	30° 45° 60°	Carbide, Powdered Metal	3.9" 99mm	0.31" 7.9mm	0.15" 3.9mm
150S	30° 45° 60°	Powdered Metal, Carbide-Tipped	2.75" 70mm	0.62" 15.7mm	0.37" 9.5mm
150SA	30° 45°	Carbide-Tipped	2.75" 70mm	0.62" 15.7mm	0.37" 9.5mm
150	30°	Powdered Metal	5.25"	0.62"	0.37"
150	45°		133.4mm	15.7mm	9.5mm



*Carbide = Tungsten Carbide (Hardness approximately 92 Rockwell A),
Powdered Metal (Hardness 63 – 65 Rockwell C).
**Varies with material hardness, cone angle and marking head

MARKERS	APPLICATIONS	NOMINAL STROKE LENGTH	TYPICAL MAX DEPTH OF MARK**
TMP1700, TMM4200, TMM5400	Great for high resolution graphics and 2-D codes with multi-pixel cells. Pneumatically driven. Light marking in plastic or soft metals. Extremely fast marking, especially in multi-pin markers.	0.14" 3.5mm	0.001 – 0.003" 0.02mm
TMP4210, TMM5400, TMP3200, TMM4200, TMM4215, TMM4250	Very fast, limited penetration marking. For marking small characters on relatively smooth surfaces. Pneumatically driven.	0.38" 9.6mm	0.0025 – 0.011" 0.06 – 0.28mm
TMP6100, TMM5100, TMP1700, TMP3200, TMM7200	Fast, limited penetration marking. For marking small characters on relatively smooth surfaces. Pneumatically driven.	0.50" 12.7mm	0.0025 – 0.016" 0.06 – 0.40mm
TMP6100, TMM5100, TMM7200, TMP1700, TMP3200, DPP2000	Similar to 25L. Extra length for recessed or hard to reach marking surfaces. Pneumatically driven.	0.50" 12.7mm	0.0025 – 0.016" 0.06 – 0.40mm
TMP1700, TMP3200, TMP6100, Benchmark® 200, Benchmark®320, Benchmark® 460	Fast, limited penetration marking. For marking small characters on relatively smooth surfaces. Electrically driven.	0.15" 3.8mm	0.0025 – 0.011" 0.06 – 0.28mm
TMM5100, TMM7200	For deep marks, large dots and characters, and/or rough surfaces. Pneumatically driven.	0.75" 19mm	0.006 – 0.022" 0.15 – 0.56mm
TMP6100, TMM5100, TMM7200, TMP1700	Similar to 101. High speed marking. Pneumatically driven.	0.25" 6.35mm	0.006 – 0.022" 0.15 – 0.56mm
TMP6100, TMP3200, TMM4200, TMM4215, TMP4210, TMM4250, TMM7200, TMP1700	Similar to 150S.	0.75" 19mm	0.006 – 0.022" 0.15 – 0.56mm
TMM7200, TMP7000	Very heavy duty, deep penetration, large character marking; and/or very rough surfaces such as castings and mill surfaces. Pneumatically driven.	1.00" 25.4mm	0.020 – 0.030" 0.51 – 0.76mm

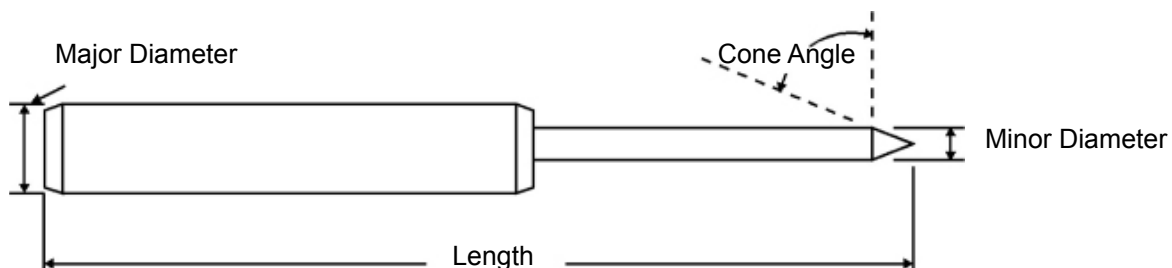

FEATURES	TMP6100	TMM5100	TMP3200	TMM7000	TMM7200	TMM4200/4215	TMP4210
	Versatile Tabletop Marker for Batch Processes/Job Lots or On-Line Processes	Rapid, On-Line, Hand-Held, or Automated Marking, VIN Numbers	Cost-Effective On-Line High Speed Marking	Heavy-Duty, Large Character, Deep Penetration Marking	Heavy-Duty, Large Character, Deep Penetration Marking	High Speed Lightweight, Hand-Held Marking or Fixtured Applications with Severe Spatial Constraints	Hand-Held Marking or Fixtured Applications with Severe Spatial Constraints
Controller	TMC470	TMC420	TMC470	TMC420	Various	TMC470	TMC420
Hand-Held Applications		•	Consult Factory	Consult Factory	•	•	Yes
Mark Depth (Based on Rb53 Material Hardness)	0.001-0.013 in. (.03-.33mm)	0.001-0.013 in. (.03-.33mm)	0.001-0.013 in. (.03-.33mm)	0.001-0.022 in. (.03-.56mm)	0.001-0.010 in. (.03-.25mm)	0.001-0.010 in. (.03-.25mm)	0.001-0.013 in. (.03-.33mm)
Noise Level	Moderate	Moderate	Moderate	Moderate	Moderate	Moderate	Moderate
Computer Required	No	No	No	No	No	No	No
PS-OCR Readable Fonts	•	•	•	•	•	•	•
Marking Speed - MAX	Up to 3 Char./Sec.	Up to 6 Char./Sec.	Up to 6 Char./Sec.	Up to 2 Char./Sec.	Up to 21 Char./ 1.5 sec.	4200-Up to 8 Char./Sec. 4215-Up to 4 Char/Sec	Up to 8 Char./Sec.
Maximum Marking Window Size	6 x 12 in. (152 x 304mm)	0.625 x 4.5 in. (16 x 114mm)	4 x 6 in. (100 x 150mm)	4 x 6 in. (100 x 150mm)	64 sq. in. (413 sq. mm)	0.50 x 4.00 in. (13x 100mm)	0.50 x 2.00 in. (13x 50mm)
Maximum Character Height	6.0 in. (152mm)	0.63 in. (16mm)	4 in. (100mm)	4 in. (100mm)	1.75 in. (44.5mm)	0.50 in. (13mm)	0.50 in. 13mm
Programmable "Z" Axis	Optional		Optional				
Maximum No. of Pins	1	6	1	1	21	4200- 4 / 4215- 2	1
Multiple Line Marking	•	•	•	•	•	•	•
Arc Text	Yes	Yes	Yes	Yes	Custom Software	No	No
Continuous Characters	•	•	•	•	•	•	•
Logos	Yes	Optional Software	Optional S.W./Yes	Custom Software	Custom Software	Optional Software	Optional Software
2-D Codes	Yes		Yes	Yes	Yes	Yes	Yes
Serialization	•	•	•	•	•	•	•
Date Codes	•	•	•	•	•	•	•
Surface Irregularities	Up to 0.25" (6mm)	Up to 0.25" (6mm)	Up to 0.25" (6mm)	Up to 0.25" (6mm)	Up to 0.25" (6mm)	Up to 0.25" (6mm)	Up to 0.25" (6mm)
Number of Std. Fonts	3	3	3	3	3	3	3
User Defined Custom Fonts	Optional Software	Optional Software	Optional Software	Optional Software	Optional Software	Optional Software	Optional Software
Host Interface	Yes	Yes	Yes	Yes	Yes	Yes	Yes
Resolution	Up to 200 dpi (79 d/cm)	Up to 200 dpi (79 d/cm)	Up to 200 dpi (79 d/cm)	Up to 200 dpi (79 d/cm)	Up to 200 dpi (79 d/cm)	Up to 200 dpi (79 d/cm)	Up to 200 dpi (79 d/cm)
Power	115 or 220 VAC	115 or 220 VAC	115 or 220 VAC	115 or 220 VAC	115 or 220 VAC	115 or 220 VAC	115 or 220 VAC
Air Supply	60-100 PSIG (4.1-6.9 Bars)	60-100 PSIG (4.1-6.9 Bars)	60-100 PSIG (4.1-6.9 Bars)	60-100 PSIG (4.1-6.9 Bars)	60-100 PSIG (4.1-6.9 Bars)	60-100 PSIG (4.1-6.9 Bars)	60-100 PSIG (4.1-6.9 Bars)
Circumferential Marking	Optional		Optional				

TMM4250	TMP1700	TMM5400	SC3500	SC5000	BenchMark®200	BenchMark®320	BenchMark®460
Fixtured Applications in Wet or Dirty Environments	Extremely Cost-Effective On-Line, High Speed Marking	8-Pin Marking Head for Extremely High Speed On-Line Applications	Nearly Silent, Moderate Penetration Scribe Marking	Nearly Silent, Deep Penetration Scribe Marking	Stand-Alone Benchtop Applications	Stand-Alone Benchtop Applications	Stand-Alone Hand-Held Applications
TMC470	TMC470	TMC420	TMC420	TMC420	Benchmark®	Benchmark®	Benchmark®
	Consult Factory	Consult Factory	Consult Factory	Consult Factory			Yes
0.001-0.013 (.03-.33mm)	0.001-0.013in. (.03-.33mm)	0.001-0.010 in. (.03-.25mm)	Varies	Varies	0.001-0.010 in (.03-.25mm)	0.001-0.010 in (.03-.25mm)	0.001-0.010 in. (.03-.25mm)
Moderate	Moderate	Moderate	Very Low	Very Low	Moderate	Moderate	Moderate
No	No	No	No	No	No	No	No
•	•	•	•	•	•	•	•
Up to 8 Char./Sec	Up to 6 Char./Sec	Up to 32 Char. in 2 Seconds	Up to 2 Char./Sec.	Up to 2 Char./Sec.	Up to 5 Char./Sec.	Up to 5 Char./Sec.	Up to 5 Char./Sec.
0.50 x 2.00 in. (13 x 50mm)	1.50 x 2.50 in. (38.1 x 63.5mm)	0.5 x 3.78 in. (12.7 x 96mm)	4 x 6 in. (100 x 150mm)	2.5 x 7.5 in. (63.5 x 190.5mm)	4 x 4 in. (100 x 100mm)	4 x 6 in. (100 x 150mm)	1 x 4 in. (25 x 100mm)
0.50 in. (13mm)	1.50 in. (38.1mm)	0.5 in. (12.7mm)	4 in. (100mm)	2.5 in. (63.5mm)	4 in. (100mm)	4 in. (100mm)	1 in. (25mm)
	Optional						
4	1	8	1	1	1	1	1
•	•	•	•	•	•	•	•
No	Yes	No	Yes	Yes	Yes	Yes	Yes
•	•	•	•	•	•	•	•
Optional Software	Optional S.W./Yes	Optional Software	Optional Software	Optional Software	Optional Software	Optional Software	Optional Software
•	•	•	•	•	•	•	•
•	•	•	•	•	•	•	•
Yes	Yes	Yes			Yes	Yes	Yes
Up to 0.25" (6mm)	Up to 0.25" (6mm)	Up to 0.25" (6mm)	Up to 0.3" (7mm)	Up to 0.5" (12mm)	Up to 0.10 (2.5mm)	Up to 0.10 (2.5mm)	Up to 0.10 (2.5mm)
3	3	3	2	2	3	3	3
Optional Software	Optional Software	Optional Software	Optional Software	Optional Software	Optional Software	Optional Software	Optional Software
Yes	Yes	Yes	Yes	Yes	No	No	No
Up to 200 dpi (79 d/cm)	Up to 200 dpi (79 d/cm)	Up to 200 dpi (79 d/cm)	Continuous	Continuous	Up to 200 dpi (79 d/cm)	Up to 200 dpi (79 d/cm)	Up to 200 dpi (79 d/cm)
115 or 220 VAC	115 or 220 VAC	115 or 220 VAC	115 or 220 VAC	115 or 220 VAC	115 or 220 VAC	115 or 220 VAC	115 or 220 VAC
60-100 PSIG (4.1-6.9 Bars)	60-100 PSIG (4.1-6.9 Bars)	60-100 PSIG (4.1-6.9 Bars)	60-100 PSIG (4.1-6.9 Bars)	60-100 PSIG (4.1-6.9 Bars)	None	None	None
		Optional			Optional	Optional	



CORPORATE HEADQUARTERS

Telesis Technologies, Inc.
28281 River Drive, Circleville, Ohio 43113
Tel 800-654-5696
Fax +1-740-477-5001
Sales 800-654-5696
Customer Service 800-867-8670
www.telesis.com

WORLDWIDE LOCATIONS

Telesis Systemes de Marquage
Parc International d'Enterprises Arlington,
4 Bd Michael Faraday,
F-77716 Marne La Vallee Cedex 4 - SERRIS
Tel +33 (0)1 60.42.88.19
Fax +33 (0)1 60.42.87.80

TelesisEagle Ltd.
Dolphin Street, Colyton,
Devon, UK, EX24 6LU
Tel +44 (0) 1297 551313
Fax +44 (0) 1297 551319
uksales@telesistech.com

Telesis Europe B.V.
Innsbruckweg 104,
3047 AH Rotterdam, The Netherlands
Tel +31 (0)10 462 2136
Fax +31 (0)10 462 3863

Telesis MarkierSysteme GmbH
Wulfingstrasse 6,
D-42477 Radevormwald, Germany
Tel +49 (0) 2191 60908-0
Fax +49 (0) 2191 60908-88

Telesis China
No. 5 Bldg, 888 Pangjin Road
Wuijiang Economic Development Zone
Jiangsu, P.R. China, 215200
Tel +86-512-63496037
Fax +86-512-63496266

For more information on the entire line of flexible and programmable permanent marking systems please call 800-867-8670 or visit www.telesis.com

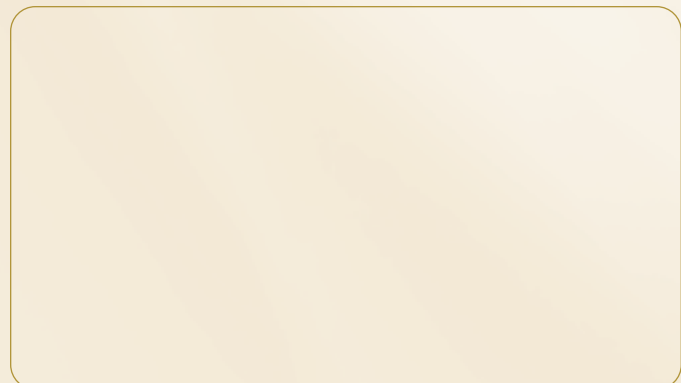



PIN MARKING SYSTEMS

Fully programmable **PINSTAMP**® Single and Multiple-Pin Marking Systems are based on Telesis' original, patented "Floating Pin" design. A pneumatically driven and returned metal pin permanently indents the marking surface with either dot matrix or continuous line characters — even logos, graphics or 2-D* Codes. Since the marking pin "floats" on constant return air pressure, surface irregularities up to ¼" are easily accommodated. And, no stress concentrations occur. Since the force of the mark is controlled by air pressure, product marking can be "customized" to suit most any application. Telesis manufactures over 10 versatile **PINSTAMP**® Models. They are cost-effective in a wide range of stand-alone or on-line manufacturing situations.

TELESCRIBE® Marking Systems inscribe high quality, continuous line characters in materials from plastics to hardened steel — in virtual silence. Other Pin Marking Systems include the **BENCHMARK**® Series of low cost markers for stand-alone, benchtop and hand-held applications, and **IDENTIPLATE**®, which provides efficient, automated tag marking for a variety of industrial or consumer products.

QUALITY - ISO9001

At Telesis, manufacturing management processes must comply with rigorous ISO Quality Standards. Product Testing in every phase of production ensures reliability throughout the life of your marking system.

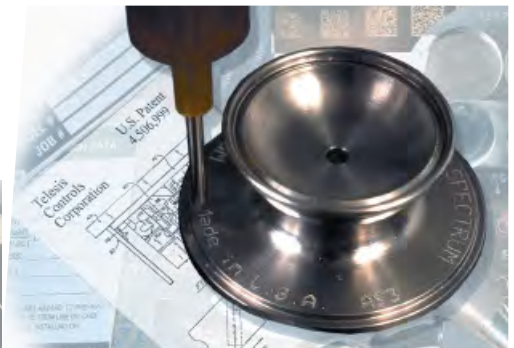
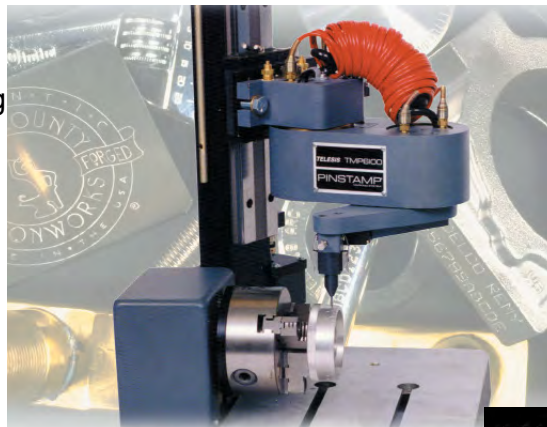

1K6PT37H0M6927828

CUSTOM ENGINEERED SOLUTIONS

Telesis is the leader in custom engineered/factory integrated marking technology. Whether it's a fully automated on-line application or a stand-alone manual workstation, Telesis Applications Engineers will work with you to solve your parts handling and custom software needs.

They can integrate any of our standard marking products within your specific application. You can expect a responsive, cost-effective, quality design solution to meet your unique requirements.



To learn more – or discuss a Custom Engineered Marking System, call 800.654.5696 TODAY – or visit us at www.telesis.com.

*Most Telesis Marking Systems are in compliance with the U.S. Department of Defense UID Requirements and ATA SPEC 2000 Aerospace Industry Standards for Data Matrix™ 2-D Code Parts Marking. Data Matrix™ is a registered trademark of Robotic Vision Systems, Inc.

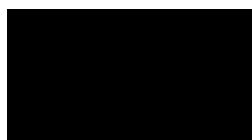

All product descriptions subject to change without notice. Please refer to Product Specification Sheets or call the Applications Engineering Department at 800.654.5696 for current information.



TABLE of CONTENTS

Service and Support	Page 4
EV10, EV15 and EV25 Diode-Pumped Solid State Lasers	Page 5-7
Outstanding beam quality makes these lasers uniquely capable among near IR lasers for marking of high resolution graphics, fine text or 2-D codes.	
EY5 and EV7-SERIES Diode-Pumped Solid State Lasers	Pages 8-9
These Diode-Pumped, Solid State Laser Marking Systems are extremely reliable, low cost alternatives to other laser designs.	
EV4G Green Laser	Page 10
This fiber-coupled, diode-pumped, solid state, green wavelength laser marking system provides laser beam and Q-switched pulse characteristics optimized for applications that require high beam quality and stability.	
LY100 Lamp-Pumped Solid State Laser	Page 11
For the ultimate in high speed, high quality marking of hard surfaces and materials.	
F-SERIES FIBER LASERS — FQ10, FQ20 AND FQ20DH	Pages 12-13
Select the F-SERIES FQ10 for low to medium speed applications and the F-SERIES FQ20 when higher power/faster process speeds are required. The FQ20 features upgraded power, and both lasers offer the long-term safeguard of a built-in, optical isolator. The FQ20DH is a dual head version for extremely high throughput applications.	
CO-SERIES CO₂ Lasers	Page 14
Available in 10, 30, and 50 watt configurations, CO-Series CO ₂ Lasers are the choice for marking substrates like wood, glass, ceramics and fabrics.	
MERLIN® II LS Laser Software	Page 15
Designed to drive all core Telesis Laser Products. Simply highlight, click and mark!	
LASER MARKING SYSTEM SELECTION GUIDE	Pages 16-18
LASER MARKER ENCLOSURE, ACCESSORIES AND SYSTEM INTEGRATION	Page 19
Telesis offers a wide range of laser mark enclosures and other system accessories.	
TMP6100/470 PINSTAMP® Marking System	Page 20
The Single Pin TMP6100 is the most versatile PINSTAMP® Marking Head. It is easily integrated into either on or off-line applications. Since the marking pin can be positioned anywhere in the generous 6" x 12" (152 x 304mm) marking window, the TMP6100 can mark any character height or style, or number of lines desired. Its robotic design allows clear access to the marking window for loading and unloading of parts.	
TMC470 Marking System Controller	Page 21
The TMC470 is a truly state-of-the-art, compact, self-contained controller. Available with the TMP6100, TMP1700, TMP3200, TMM4250 and TMM4200 marking heads.	
MERLIN® III Visual Design Software	Page 21
Telesis' new WIN 32 Merlin® III Visual Design Software makes pattern design quick and intuitive. "WYSIWYG" (what you see is what you get) displays a to-scale image of the pattern as it's created. Just "click & drag" for immediate adjustments to field size, location or orientation.	
TMP1700/470 PINSTAMP® Marking System	Page 22
The TMP1700/470 is the lowest cost PINSTAMP® Marking System. The rugged Single Pin TMP1700 marking head features a compact, 1-1/2" x 2-1/2" (38.1 x 63.5mm) window, and marking speeds up to six characters per second. It's an excellent choice for many factory-automated or on-line processes. When combined with optional mounting post and base, the TMP1700 is cost-effective in off-line marking applications, too.	
TMP4210/420 PINSTAMP® Marking System	Page 23
The TMP4210/420 is an extremely lightweight, hand-held, single pin marker satisfying a wide range of portable marking applications. Its robust rack-and-pinion design and compact envelope also make it the right choice for many high production, on-line applications.	
TMP3200/470 PINSTAMP® Marking System	Page 24
The TMP3200/470 is a rugged, cost effective utility marker for on-line and off-line high speed marking applications. Its low-maintenance design features a 4" x 6" (100 x 150mm) marking window for multi-line text, and marking speeds up to six characters per second.	



TABLE of CONTENTS

TMC420 Marking System Controller	Page 25
The TMC420 is a versatile, compact system controller that can be used with most PINSTAMP® marking heads. The TMC420 is fully self-contained and requires no Personal Computer.	
TMM5400/420 PINSTAMP® Marking System	Page 26
With eight pins marking simultaneously, the TMM5400 is the fastest dot peen marker available. It can mark up to 16 characters per second in soft plastics or hardened steel. Choose from a variety of marking pins and cartridges to optimize window size and cycle time combinations.	
TMM4200/470 PINSTAMP® Marking System	Page 27
The unique TMM4200 Multiple Pin Marking Head can mark up to eight characters per second at depths to .013" (.33mm). Weighing 4.5 pounds, its compact, hand-tool like design with pistol-grip handle makes the TMM4200 the ultimate hand held permanent marker.	
TMM4215/420 PINSTAMP® Marking System	Page 28
Based on the TMM4200/420 design, the TMM4215/420 provides a marking window twice the size of the TMM4200/420.	
TMM4250/470 PINSTAMP® Marking System	Page 29
The TMM4250/470 Multiple Pin Marking System can mark up to eight characters per second. A NEMA 12 (IP55) enclosure with industrial grade, protective rubber "boot" makes it highly resistant to both solid and liquid contaminants. The TMM4250 features an extremely compact envelope. It can be integrated easily within a wide range of manufacturing settings.	
TMM5100/420 PINSTAMP® Marking System	Page 30
With up to six pins marking simultaneously, the TMM5100 Multiple Pin Marking system can mark up to six characters per second. Its lightweight, compact design and minimal footprint make it ideal for either automated or hand-held operations. A variety of pin cartridges are available for optimal character size/depth, cycle times and marking window areas.	
TMP7000 PINSTAMP® Marking System	Page 31
The TMP7000 is a powerful, heavy duty marking system for deep marking applications. This single pin marker is capable of marking characters up to .025" (.63mm) deep on mild steel.	
TMM7200 PINSTAMP® Marking System	Page 32
The TMM7200 is an extremely heavy duty marking system. It is the right choice for deep penetration marking of large characters. The flexible TMM7200 can be configured with up to 21 marking pins to print 21 characters in 1.5 seconds.	
SC3500/420 and SC5000/420 TeleScribe® Marking Systems	Page 33-34
For virtually silent marking, the economically priced SC3500/420 features a 4" x 6"(100 x 150mm) marking window. The powerful, heavy duty SC5000/420, with a 2.5" x 7.5" (63.5 x 190.5mm) marking window is particularly well suited for VIN marking applications.	
BenchMark®460 Hand-Held Marking System	Page 35
The BenchMark®460 is a fully programmable, cost effective alternative to old-fashioned permanent marking techniques for parts too large or heavy to be carried to a marking station.	
BenchMark®200 and 320 Benchtop Marking Systems	Page 36-37
These are extremely affordable benchtop markers equipped with an electromechanical marking pin.	
Pin Marker Product Accessories and System Intergration	Page 38
Choose from a variety of options and customized solutions to enhance your Telesis Marking System.	
2-D and UID Code Marking and Verification	Page 39
2-D and UID Code applications, where accurately marked codes are the key to readability.	
IMPACT PIN SELECTION GUIDE	Pages 40 – 41
PIN MARKING SYSTEM SELECTION GUIDE	Pages 42 – 43

All of our systems — standard and custom — are designed and built to your specifications at our 46,000 square foot (4087 square meter) facility located in Circleville, Ohio. We maintain state-of-the-art manufacturing tools for all of the mechanical, electrical and software functions needed to support your marking system. Telesis also maintains Sales and Distribution Offices in The Netherlands, Germany, England, and China.



Customer Service

At Telesis, Customers come First. Our Order Entry Specialists are fully trained to help with questions on pricing, product capabilities, accessories, spare parts and availability. They provide timely up-dates on the status of your order. Call us at **800-654-5696** for the answers!

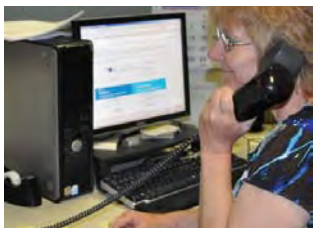

Training

Telesis' commitment to customers is evident in our Training Facility. It features classroom-oriented and hands-on product training by experienced instructors. Our 3,000 square foot facility gives us the flexibility to easily accommodate up to 40 people in a classroom setting.



Technical Service

We back our customers with support and service for every system we build — world-wide. This includes on-site installation and start-up by our experienced Field Service Engineers. They'll even train your operating personnel — further assurance that your Telesis Marking System will perform dependably.

Have a technical question or concern? Telesis Service Technicians are available 24 hours a day — every day — to help you. Often, they can troubleshoot and fix a problem over the phone, saving you time and money. Call our Technical Service Department at 800.867.8670 or e-mail a Telesis Service Technician at technical_services@telesistech.com.



Smaller groups use product work-stations for a very effective, individual learning experience. On-site customized training for the customer can be also be developed as needed to meet the customers needs.

Our Warranty and Guarantee

Every Telesis Marking System carries a complete Parts and Service Warranty. During this time, we can ship replacement parts, free of charge, overnight in the continental United States. Plus, component exchange programs for reconditioned equipment can reduce downtime.



Extended Service warranties are available for all Telesis Marking Equipment. Contact your Telesis Representative or our Customer Service Department for details.

At Telesis, we're dedicated to support you for the life of your Marking System. We're with you 100% of the way.





E-SERIES EV25 Diode-Pumped Solid State Laser

The EV25 is the latest advancement in the Telesis E-series family of laser marking systems, offering 25W of power in a high quality laser beam. It is the solution to the most demanding marking application in automotive, medical, aerospace, and other commercial and industrial markets. The enhanced performance of the EV25 provides a solution for marking applications that require special characteristics such as deep marking, fast cycle times and high resolution marks.



Engraved approximately 4mm deep in aluminum



Engraved approximately 2mm deep in aluminum

LASER MARKER SPECIFICATIONS

Compliance.....	CDRH, CE
Wavelength.....	1064 nm
Laser Type.....	Fiber-coupled diode end-pumped, Q-switched Nd:YVO4 laser
Laser beam mode.....	TEM ₀₀
CW Power.....	25 Watts
Positioning.....	Visible Red Diode Light
Optical Fiber Length.....	1.75 meters (5.74 feet) standard 4.75 meters (15.58 feet) optional
Cooling.....	Air-cooled, active thermo-electric
Maxium Power Consumption.....	Less than 800 Watts
Operating Temperature Range.....	18° to 30° C (65° to 86° F)
Humidity.....	10% to 85% Non-condensing
Mounting Weight.....	Approx. 24 kg (53 lbs.)
Marketing Head Dimensions.....	66.3 (L) x 23.8 (W) x 21.3cm (H) (26.1" x 9.4" x 8.4")
Controller Dimensions.....	42 (W) x 14 (H) x 50cm (L) (16.5" x 5.5" x 19.5")



Features DATA MATRIX™ 2-D Code Marking Capability —
Meets all Department of Defense UID Requirements



E-SERIES EV25 Diode-Pumped Solid State Laser

At the heart of the EV25 marking system is our air cooled, high power, industrial grade 25W, diode-pumped, solid-state vanadate laser. It is designed to operate in the harshest of environments while maintaining peak performance for many thousands of hours of maintenance-free operation. When the time comes for maintenance and component replacement, most can be done onsite thanks to its modular design, eliminating the need to return the laser to the factory, resulting in lost revenue due to non-productive downtime.

The EV25 offers a broad range of laser performance that allows the user to tailor its operation for maximum results in the final mark. The EV25 offers distinct advantages over fiber lasers and other solid state lasers due to its superior beam quality, resulting in smaller focused spot sizes and a longer working depth of field than other lasers can offer. The key features of the EV25 provide the strength to tackle metals such as stainless steel, cobalt, and titanium, as well as provide the high marking speeds required for marking-on-the-fly (MOTF). It also provides the fine detail to do trimming, edge heat treating, and even marking delicate materials like plastics, foils, and labels. It produces superb annealed marks that stand up to the harshest of tests, high resolution 2D codes, and can even produce unique color marks on various metals. The EV25 can do all of this while providing customers with a quick return on investment as it meets their production requirements.



Model E9A Controller

LENS CONFIGURATION AVAILABLE

FOCAL LENGTH	MARKING FIELD
100mm	65mm X 65mm (2.56" X 2.56")
160mm	110mm X 110mm (4.33" X 4.33")
254mm	175mm X 175mm (6.88" X 6.88")
330mm	230mm X 230mm (9.06" X 9.06")
350mm	250mm X 250mm (9.84" X 9.84")
420mm	290mm X 290mm (11.42" X 11.42")

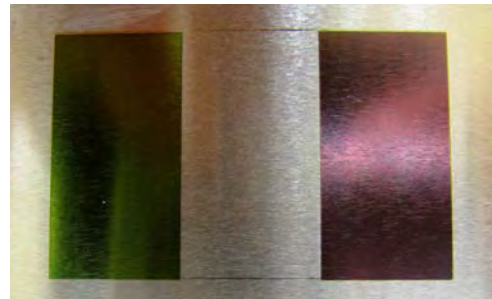

Color Marking on Stainless Steel

SOFTWARE

Software.....**MERLIN**® II LS (see page 15)
 Operating System.....Windows® 2000, Windows XP,
 or Windows Vista™
 Desktop PC (Std), Optional Laptop
 Communication Interface.....Serial, TCP/IP, I/O



Features DATA MATRIX™ 2-D Code Marking Capability —
 Meets all Department of Defense UID Requirements



E-SERIES EV7 Diode-Pumped Solid State Laser

The Telesis EV7 marker is based on an advanced Q-Switched, fiber-coupled diode end-pumped Nd: YVO₄ laser for applications requiring high beam quality and stability. Its exceptional power stability at all power levels makes the EV7 an ideal choice for high speed marking on delicate and heat sensitive electronic components, thin foils and medical instruments. The EV7 is completely air cooled with a very compact, easily integrated package requiring very little maintenance. With an expected lifetime for the pump diode of over 20,000 hours, down time is dramatically reduced. Because of the modular fiber coupled design, diode replacement can be completed quickly with no need to realign the laser.

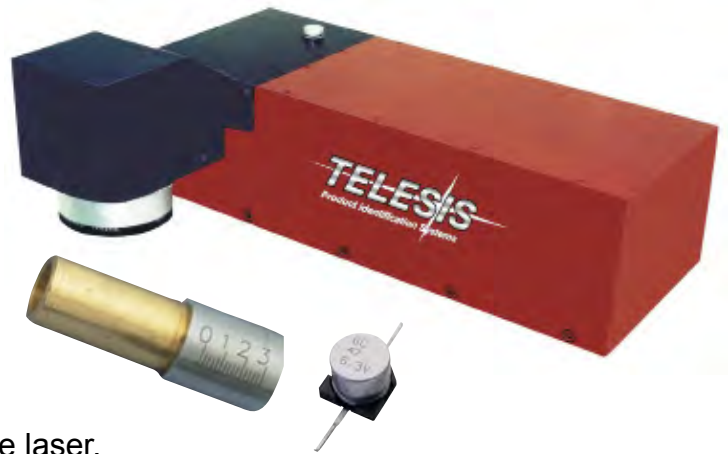

MODEL XP1 SYSTEM CONTROLLER

LASER MARKER SPECIFICATIONS

Compliance.....	CDRH, CE
Wavelength.....	1,064 nm
Laser Type.....	Fiber-coupled diode end-pumped, Q-switched Nd:YVO ₄ laser
Laser Beam Mode	TEM ₀₀
CW Power	7W
Positioning	Visible Red Diode Light
Optical Fiber Length	1.75 meters (5.74 feet) standard 4.75 meters (15.58 feet) optional
Cooling	Air Cooled, active thermo-electric
Operating Temperature Range	18° to 35°C (65° to 95° F)
Humidity.....	10% to 85% Non-condensing
Mounting Weight.....	approx. 13.6Kg (30 lb.)
Marking head dimensions.....	31.75 (W) x 15.72 (H) x 42.9cm (L) (12.5" x 6.187" x 16.885")
XP1 Controller dimensions.....	43 (W) x 14 (H) x 51cm (L) (17" x 5.5" x 20")
Input Power (selectable).....	115/230 VAC 50/60 Hz
Max. Power Consumption.....	Less than 500W

STANDARD LENS CONFIGURATION

FOCAL LENGTH	MARKING FIELD
100mm	65mm X 65mm (2.56" X 2.56")
160mm	110mm X 110mm (4.33" X 4.33")

Other lens configurations are available

SOFTWARE

Software	MERLIN® II LS (see page 15)
Operating System	Windows® 2000, Windows XP, or Windows Vista™
Desktop PC (Std), Optional Laptop	
Communication Interface	Serial, TCP/IP, I/O



The Telesis EY5 marker is based on an advanced Q-switched, fiber-coupled diode end-pumped Nd:YAG laser, which provides high pulse energies and exceptional beam quality for marking, scribing, trimming, and other material processing applications. The EY5 is a completely air cooled, very compact, easily integrated package requiring very little maintenance. With an expected lifetime for the pump diode of over 20,000 hours, down time is dramatically reduced. Because of the modular fiber coupled design, diode replacement can be completed quickly with no need to realign the laser. The EY5 is an extremely reliable, low cost alternative to other laser markers.



LASER MARKER SPECIFICATIONS

Compliance.....	CDRH, CE
Wavelength.....	1,064 nm
Laser Type.....	Fiber-coupled diode end-pumped, Q-switched Nd:YAG Laser
Mode.....	TEM ₀₀
CW Power	5W
Positioning	Visible Red Diode Light
Optical Fiber Length	1.75 meters (5.74 feet) standard 4.75 meters (15.58 feet) optional
Cooling	Air Cooled, active thermo-electric
Max. Power Consumption	Less than 500W
Operating Temperature Range	18° to 35° C (65° to 95° F)
Humidity.....	10% to 85% Non-condensing
Mounting Weight.....	approx. 13.6Kg (30 lb.)
Marking Head Dimensions	31.75 (W) x 15.72 (H) x 42.9cm (L) (12.5" x 6.187" x 16.885")
XP1 Controller Dimensions	43 (W) x 14 (H) x 51cm (L) (17" x 5.5" x 20")
Input Power (Selectable)	115/230 VAC, 50/60 Hz
Max. Power Consumption.....	Less than 500W

STANDARD LENS CONFIGURATION

FOCAL LENGTH	MARKING FIELD
100mm	65mm X 65mm (2.56" X 2.56")
160mm	110mm X 110mm (4.33" X 4.33")

Other lens configurations are available

SOFTWARE

Software.....	MERLIN ® II LS (see page 15)
Operating System	Windows® 2000, Windows XP, or Windows Vista™
Desktop PC (Std), Optional Laptop	
Communication Interface	Serial, I/O and Host Capable

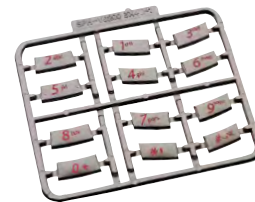

Features DATA MATRIX™ 2-D Code Marking Capability —
 Meets all Department of Defense UID Requirements



MODEL XP1 SYSTEM CONTROLLER



E-SERIES EV4G Green Laser

The EV4G marker is based on an advanced Q-switched, fiber-coupled, diode end-pumped and frequency doubled (green wavelength) Nd: YVO4 laser. Its laser beam and Q-switched pulse characteristics are optimized for applications that require high beam quality and stability. The 532nm wavelength of the EV4G offers extra power and speed for precision marking, scribing, trimming and other material processing that is not well suited for near IR or CO2 wavelength lasers. The robust mechanical and optical design of the EV4G enables operation in industrial environments where shock, vibration and dust are a concern. The EV4G is a completely air-cooled, very compact, easily integrated package requiring very little maintenance. With an expected life-time for the pump diode of over 20,000 hours, downtime is dramatically reduced. Because of the modular fiber coupled design, diode replacement can be completed quickly with no need to re-align the laser.



XP1 Laser Controller with temperature Controller

LASER MARKER SPECIFICATIONS

Compliance.....	CDRH, CE
Wavelength.....	532 nanometers (nm)
Laser Type.....	Fiber-coupled diode end-pumped, Q-switched Nd:YVO ₄ laser
Average Power (at 20KHZ).....	4W
Positioning.....	Visible Red Diode Light
Optical Fiber Length	1.75 meters (5.74 feet) standard 4.75 meters (15.58 feet) optional
Cooling	Air Cooled, active thermo-electric
Maximum Power Consumption.....	Less than 600 watts
Mounting Weight.....	approx. 25Kg (55 lbs.)
Operating Temperature Range.....	18° to 30°C (65° to 86° F)
Humidity.....	10% to 85% Non-condensing
Marking Head Dimensions	68.6 (L) x 24.5 (W) x 19.1cm (H) (26.99" x 9.658" x 7.524")
Temperature Controller Dimensions	21.3 (W) x 9.6 (H) x 21.2cm (D) (8.4" x 3.7" x 8.3")
XP1 Controller Dimensions	43 (W) x 14 (H) x 51cm (L) (17" x 5.5" x 20")
Input Power (selectable).....	115/230 VAC 50/60 Hz



LENS CONFIGURATIONS AVAILABLE

FOCAL LENGTH	MARKING FIELD
100mm	55mm X 55mm (2.17" X 2.17")
160mm	110mm X 110mm (4.33" X 4.33")
250mm	170mm X 170mm (6.69" X 6.69")

SOFTWARE

Software	MERLIN ® II LS (see page 15)
Operating System	Windows® 2000, Windows XP, or Windows Vista™
Desktop PC (Std), Optional Laptop	
Communication Interface	Serial, TCP/IP, I/O



Features DATA MATRIX™ 2-D Code Marking Capability —
Meets all Department of Defense UID Requirements



F-SERIES FQ10, FQ20 and FQ20DH Fiber Lasers

Innovative, compact and flexible F-SERIES Fiber Lasers are perfectly suited for marking applications that require 24/7 “set and forget”, unattended operation.

Select the 10W FQ10 for low to medium speed applications and the 20W FQ20 when higher power/faster process speeds are required. Both lasers offer the additional long-term safeguard of built-in, polarization/optical isolators.



Example — Laser marking on Coated Label Stock



LASER MARKER SPECIFICATIONS

Compliance	CDRH, CE, CSA
Wavelength	1070nm
Laser Type	Q-Switched Ytterbium Fiber Laser
Average Power FQ10.....	10 Watts
Average Power FQ20	20 Watts
Peak Power FQ10.....	>4KW
Peak Power FQ20.....	>8KW
Beam Quality	M ² < 2
Fiber Length FQ10.....	5 Meters (16 ft) Std.
Fiber Length FQ20.....	3 Meters (9.8 ft) Std.
Optical Isolator FQ10	Standard
Optical Isolator FQ20	Standard
Positioning	Visible Red Diode Light Input Power
Input Power Selectable.....	115VAC/230VAC, 50/60HZ
Cooling.....	Air Cooled, Fan/Filter (no water cooling required)
Operating Temperature Range.....	18° to 35° C Non-Condensing (65° F to 90° F)



Model 6 Controller



Customized Part Handling Options Available



Features DATA MATRIX™ 2-D Code Marking Capability — Meets all Department of Defense UID Requirements



F-SERIES FQ10, FQ20 and FQ20DH Fiber Lasers

Powered by 110/230VAC with no water-cooling requirements, these F-Series units are extremely dependable over a long life.

"All of your employees seem to be willing and able to give that "little bit extra" to make everything go right. The laser marking equipment you have supplied to us thus far has been totally reliable and continues to perform flawlessly, helping Federal-Mogul Corporation reduce costs as it continues to improve product quality. I look forward to a continued relationship with the people I consider my "friends" at Telesis Technologies."

Best Regards,
Ed Reinemeyer
Process Engineer,
Federal-Mogul Corporation



FQ10 Marking Head dimensions for 100mm lens.....	51.0(L) x 12.7 (W) x 14.0cm (H) (20.1" x 5.0" x 5.5")
FQ10 Mounting Weight.....	6.82 kg (15 lbs.)
FQ20 Marking Head Dimensions for 100mm lens.....	51.0(L) x 12.7 (W) x 14.0cm (H) (20.1" x 5.0" x 5.5")
FQ20 Mounting Weight.....	6.82 kg (15 lbs.)
Model 6 Controller Dimensions.....	42.5 (W) x 13.7 (H) x 50.8cm (D) (16.7" x 5.4" x 20.0")

LENS CONFIGURATIONS AVAILABLE

FOCAL LENGTH	MARKING FIELD
100mm	65mm X 65mm (2.56" X 2.56")
160mm	90mm X 90mm (3.54" X 3.54")
163mm	110mm X 110mm (4.33" X 4.33")
254mm	175mm X 175mm (6.89" X 6.89")
330mm	230mm X 230mm (9.06" X 9.06")
350mm	250mm X 250mm (9.84" X 9.84")
420mm	290mm X 290mm (11.42" X 11.42")

SOFTWARE

Software	MERLIN ® II LS (see page 15)
Operating System	Windows® 2000, Windows XP, or Windows Vista™
Desktop PC (Std), Optional Laptop	
Communication Interface	Serial, TCP/IP, I/O

The FQ20DH features an advanced, dual-scan marking head that is based on our successful Pulsed-Fiber Laser platform. Capable of extremely high-speed, high quality, simultaneous, duplicate marking on two surfaces, it offers lower operation costs along with increased production and handling efficiencies. In addition to marking, the FQ20DH is an excellent choice for scribing, trimming and a variety of material processing applications.





**CO-SERIES
CO2 Lasers**

The Telesis CO-Series Laser Markers, available in three different power levels, the 10W Model CP10, the 30W Model CO30 and the 50W Model CO50, are excellent choices for many plastic, anodized metal and label marking applications.

They are perfect for “Marking-on-the Fly” as well as stationary marking. Their RF-excited CO2 tube assures a long life cycle as well and virtually maintenance-free operation. Due to their compact size and modular construction, the CO-Series Markers can go almost any place they are needed on the plant floor.



Marking Head Weight.....	13.8 kg (30.4 lbs.)(10W) 26.3 kg (58 lbs.)(30W) 25.45 kg (56 lbs.)(50W)
CW Power CO10.....	10W
CW Power CO30.....	30W
CW Power CO50.....	50W
Controller Dimensions.....	49.28(W) x 20.07 (H) x 50.80cm (D) (19.4" x 7.9" x 20.0")
CO10.....	78.10(L) x 15.93 (W) x 20.65cm (H) (30.75" x 6.27" x 8.13")
CO30.....	97.35(L) x 14.71 (W) x 20.49cm (H) (38.33" x 5.79" x 8.07")
CO50.....	114.35(L) x 14.6 (W) x 20.78cm (H) (45.02" x 5.75" x 8.18")
Controller Weight.....	14.3 kg (31.5 lbs.)
Input Weight.....	100 – 240 VAC, 50 – 60Hz
Operating Temperature Range.....	16 – 35°C (61-95°F)

STANDARD LENS CONFIGURATIONS

FOCAL LENGTH	MARKING FIELD
75mm	50mm X 50mm (1.97" X 1.97")
100mm	70mm X 70mm (2.76" X 2.76")
150mm	100mm X 100mm (3.94" X 3.94")
200mm	140mm X 140mm (5.51" X 5.51")

Other lens configurations are available

MARKING SPEED

- Up to 152 m/minute (500 ft./minute) line speed for “Mark-on-the-fly” applications*
- 400 characters/second*

*Character marking speeds and production line speeds depend on material, character size and the desired marking quality.

SOFTWARE

Software.....	MERLIN® II LS (see page 15)
Operating System.....	Windows® 2000, Windows XP, or Windows Vista™ Desktop PC (Std), Optional Laptop
Communication Interface.....	Serial, TCP/IP, I/O



Features DATA MATRIX™ 2-D Code Marking Capability —
Meets all Department of Defense UID Requirements

This powerful **Merlin® II LS** Visual Design Software is capable of driving any of the core Telesis Laser Products. Each system is shipped with a fully functioning version of the Software (on CD), that allows off-line program development.



Main Programming Screen

TELESIS LASER SOFTWARE FEATURES:

- Specially Designed by TELESIS – based on Windows® 2000, Windows XP, or Windows Vista™
- Import a wide range of Graphic Formats including DXF from AutoCAD™, WINDOWS® Bitmaps, True Type Fonts as Vector or Raster Files
- Supports 4 Axis Movement (XYZ & Rotary)
- Highlight, click and mark!

COMPUTER REQUIREMENTS:

- Pentium® III 128 Mb RAM (minimum)
- Multi-gigabyte HDD
- Video, Sound Card
- CD-ROM and 3.5" Floppy Disk Drive
- SVGA Monitor, Mouse and Keyboard

OPTIONAL AMI VERSION:

Our AMI version of Merlin II LS addresses the need for a safe, easy operator interface that allows barcode scanning to load patterns, load a picture of the part and fixture, and insert the marking data in the proper field all without the need of a keyboard- virtually mistake free.

Raster Profile

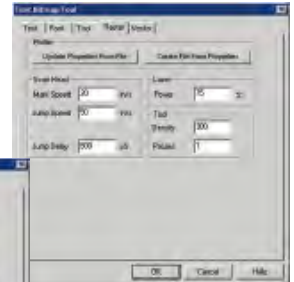

Bar Code Editor

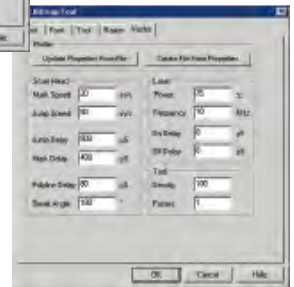

Vector Profile

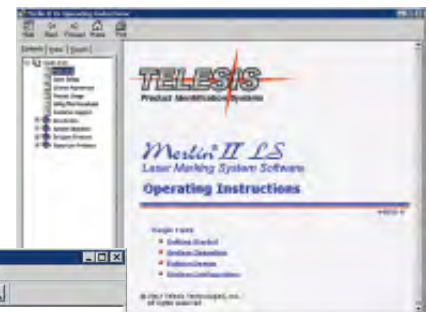

On Line Help

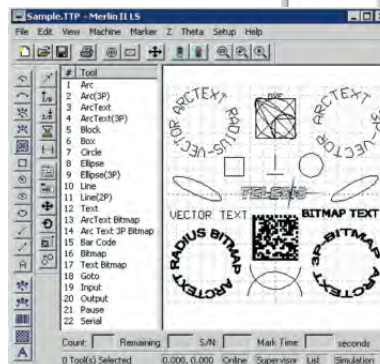

Window Overview



LASER MARKING SYSTEM SELECTION GUIDE

LASER SYSTEMS/ APPLICATIONS	FQ10	FQ20	FQ20DH	EY5
	1070nm wavelength, air-cooled, single phase, Q-switched, 10 Watt Yb fiber laser marker	1070nm wavelength, air-cooled, single phase, Q-switched, 20 Watt Yb fiber laser marker (Will provide shorter cycle times than FQ10.)	1070nm wavelength, air-cooled, single phase, Q-switched, dual scan head, 10 Watt per scanhead, Yb fiber laser marker	1064nm wavelength, air-cooled, single phase, diode end-pumped, Q-switched, 5 Watt Nd:YAG laser marker
Marking metals	Good choice for surface and deep marking of some metals. (Sensitive to back reflection. Not recommended for copper, brass or any other highly reflective or polished metals.)	Good choice for surface and deep marking of some metals. (Sensitive to back reflection. Not recommended for copper, brass or any other highly reflective or polished metals.)	Good choice for surface and deep marking of some metals. (Sensitive to back reflection. Not recommended for copper, brass or any other highly reflective or polished metals.)	Good choice for surface and deep marking all metals.
Marking plastics and label materials (3M, Tesa, etc.)	Good choice for marking many plastics and label materials. (Some surface melting can occur due to long pulse width.)	Good choice for marking many plastics and label materials. (Some surface melting can occur due to long pulse width.)	Good choice for marking many plastics and label materials. (Some surface melting can occur due to long pulse width.)	Good choice for marking plastics and label materials.
Marking silicon	Capable of deep marking of silicon.	Capable of deep marking of silicon.	Capable of deep marking of silicon.	Capable of deep marking of silicon.
Marking organic materials	Cannot mark wood. Can mark some other organic materials.	Cannot mark wood. Can mark some other organic materials.	Cannot mark wood. Can mark some other organic materials.	Cannot mark wood. Can mark some other organic materials.
Chemical marking	Can mark metals, glass and other materials using chemical marking.	Can mark metals, glass and other materials using chemical marking.	Can mark metals, glass and other materials using chemical marking.	Can mark metals, glass and other materials using chemical marking.
Marking high quality graphics	Can mark high quality graphics on some metals.	Can mark high quality graphics on some metals.	Can mark high quality graphics on some metals.	Excellent choice for marking high resolution graphics due to small spot size.
Workstation	Optional	Optional	Optional	Optional



LASER SYSTEMS/ APPLICATIONS	EV7	EV10	EV15	EV25
	1064nm wavelength, air-cooled, single phase, diode end-pumped, Q-switched, 7 Watt Nd:YVO4 laser marker	1064nm wavelength, air-cooled, single phase, diode end-pumped, Q-switched, 10 Watt Nd:YVO4 laser marker	1064nm wavelength, air-cooled, single phase, diode end-pumped, Q-switched, 15 Watt Nd:YVO4 laser marker	1064nm wavelength, air-cooled, single phase, diode end-pumped, Q-switched, 25 Watt Nd:YVO4 laser marker
Marking metals	Excellent choice for surface marking of almost every type of metal with very small heat effected zone.	Excellent choice for high speed surface marking of almost every type of metal with very small heat effected zone produced.	Excellent choice for high speed surface and deep marking of almost every type of metal.	Best choice for high speed surface and deep marking of almost every type of metal.
Marking plastics and label materials (3M, Tesa, etc.)	Good choice for marking plastics and label materials.	Excellent choice for marking plastics and label materials.	Excellent choice for high speed marking of plastics and label materials.	Excellent choice for high speed marking of plastics and label materials.
Marking silicon	Can do surface marking of silicon.	Good choice for surface and deep marking of silicon.	Excellent choice for deep marking of silicon.	Excellent choice for surface marking of silicon.
Marking organic materials	Cannot mark wood. Can mark some other organic materials.	Cannot mark wood. Can mark some other organic materials.	Cannot mark wood. Can mark some other organic materials.	Cannot mark wood. Can mark some other organic materials.
Chemical marking	Can mark metals, glass and other materials using chemical marking.	Can mark metals, glass and other materials using chemical marking.	Good choice for marking metals, glass and other materials using chemical marking.	Good choice for marking metals, glass and other materials using chemical marking.
Marking high quality graphics	Excellent choice for marking high resolution graphics due to small spot size.	Excellent choice for marking high resolution graphics due to small spot size.	Excellent choice for marking high resolution graphics due to small spot size.	Excellent choice for marking high resolution graphics due to small spot size.
Workstation	Optional	Optional	Optional	Optional





EV4G	LY100	CO10	CO30	CO50
532nm wavelength; air-cooled; single phase; diode end-pumped, Q-switched, 4 Watt green laser marker	1064nm wavelength, water-cooled, three phase, lamp pumped, Q-switched, 90W Nd:YAG laser marker	10,600nm wavelength, air-cooled, single phase, RF excited, 10W CO2 laser marker	10,600nm wavelength, air-cooled, single phase, RF excited, 30W CO2 laser marker (provides shorter cycle times than CO10)	10,600nm wavelength, air-cooled, single phase, RF excited, 50W CO2 laser marker (provides shorter cycle times than CO30)
Excellent choice for high speed surface marking all metals with very small heat effected zone produced.	Good choice for high speed surface and deep marking of almost all metals. Provides the shortest cycle times for deep marking.	Can mark some anodized metal surfaces.	Can mark anodized metal surfaces. With short focal length lenses, can mark some non-plated metal surfaces.	Can mark anodized metal surfaces. With short focal length lenses, can mark some non-plated metal surfaces.
Excellent choice for marking plastics. Marks largest variety of plastics.	Good choice for marking plastics and label materials.	Excellent choice for high speed marking of plastics and some label materials.	Excellent choice for high speed marking of plastics and some label materials.	Excellent choice for high speed marking plastics and some label materials.
Excellent choice for surface marking of silicon.	Can do deep marking and cutting of silicon.	Not recommended	Not recommended	Not recommended
Cannot mark wood. Can mark some other organic materials.	Cannot mark wood. Can mark some other organic materials.	Excellent choice for marking wood and other organic materials.	Excellent choice for marking wood and other organic materials.	Excellent choice for marking wood and other organic materials.
Cannot mark wood. Can mark some other organic materials.	Good choice for marking metals, glass and other materials using chemical marking	Good choice for marking metals, glass and other materials using chemical marking	Excellent choice for marking metals, glass and other materials using chemical marking.	Excellent choice for marking metals, glass and other materials using chemical marking.
Not recommended	Can mark high quality graphics on some metals.	Can mark high quality graphics on plastics and on some anodized metal surfaces.	Can mark high quality graphics on plastics and on some anodized metal surfaces.	Can mark high quality graphics on plastics and on some anodized metal surfaces.
Excellent choice for marking high resolution graphics due to small spot size. Highest	Optional	Optional	Optional	Optional



For all applications, it is highly recommended that samples be sent to Telesis for qualification and testing purposes.

Telesis offers a wide variety of standard Class 1 and Class 4 laser marker enclosure styles and sizes. When the situation demands it, our experienced custom engineering staff can design one to fit the specific needs of your application.

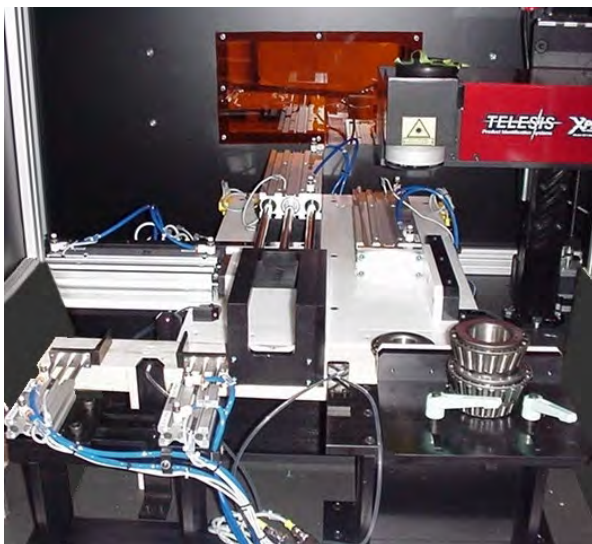
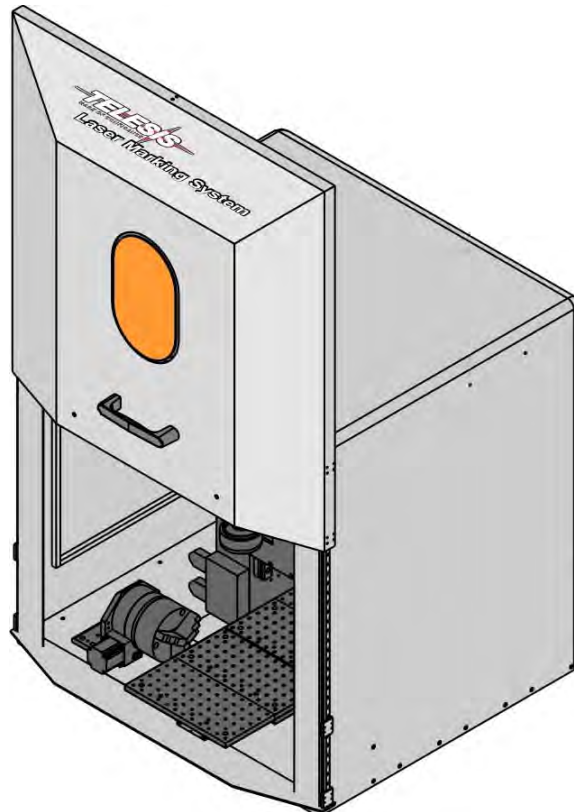

In addition, with parts handling accessories such as X/Y tables, rotary fixtures, rotary tables and manual and automated Z-axes, Telesis can provide a complete solution to your laser marking requirements.

The TMP6100 is the most versatile **PINSTAMP®** Marking Head. It is easily integrated into either on or off-line applications. Since the marking pin can be positioned anywhere in the generous 6" x 12" (152 x 304mm) marking window, the TMP6100 can mark any character height, style or number of lines desired. Its robotic design allows clear access to the marking window for loading and unloading of parts.

"The Telesis Model 6100/470 is a top quality product. They run 6 days a week, 10 hours a day, all day long, and they are 'bullet-proof'. I'd recommend the Telesis dot peen (Pinstamp) to anybody who needs that type of product marker. It is one of the best machines that we have."

Bud Nelson, Secondary Manager,
Acutec Precision Machining



FEATURES

- Large 6" x 12" (152 x 304mm) marking window
- Unique rigid positioning drive features robotic technology
- Marks a wide range of materials from soft plastics to hardened steel — up to Rc60
- Dot density up to 200 dots per inch (79 per centimeter)
- Choice of Interchangeable Marking Pin Types for depths from .001" – .018" (.02 – .45mm)
- Pin travel accommodates surface irregularities to .25" (6mm)
- Compact, self-contained TMC470 Controller with integral display and keyboard – no PC required (see page 21)
- RS232 or TCP/IP Host interface to download text to individual fields or call up entire patterns
- Automatically generates serial numbers, time, date and shift codes
- Easily interfaced to PLCs (Programmable Logic Controllers)
- Pattern backup via USB port
- Stores up to 200 marking patterns (files)

OPTIONAL ACCESSORIES

- Rotary fixtures for marking circumferences of cylindrical parts
- Marking head mounting posts, including programmable Z-axis version
- Logo/Font design Software Package for design of custom fonts or simple logos
- Powerful Windows-based **Merlin®** III software (See page 21)

Compact Self-Contained
TMC470 Controller



The TMP6100/470 contains Data Matrix® 2-D code marking capability, meeting all US Department of Defense UID requirements and other industry standards.

FEATURES

- Fully self-contained – no PC required
 - Easy-to-use menu design for pattern design and access
 - Ethernet port for TCP/IP communications
 - Durable membrane keyboard
 - Pattern backup via USB port
 - Stores up to 200 marking patterns locally
 - One RS232/485 and one RS232 serial port and discrete I/O capabilities with spare I/O available for customer-specific needs
 - Optional internal board to control third and fourth axis (Z and rotary) – no separate driver required
 - Optional panel-mount kit for panel mounting in NEMA/IP rated enclosures
 - Conforms to all European Community (CE) norms
- Operates on 100 – 130 VAC or 200 – 250 VAC, 50 – 60 Hz power



Offered as an optional accessory to a number of TMC470- based **Pinstamp®** Marking Systems, Telesis' powerful WIN 32 **Merlin®** Visual Design Software with its state-of-the art graphical user interface, makes marking pattern design quick and easy.

"WYSIWYG" (what you see is what you get) interface provides a to-scale image of the pattern as it's created. Just "click & drag" for immediate adjustment to field size, location or orientation. Pattern Wizard Mode makes simple pattern design a snap even for the computer novice.

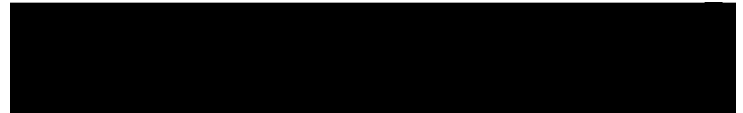

VISUAL DESIGN SOFTWARE

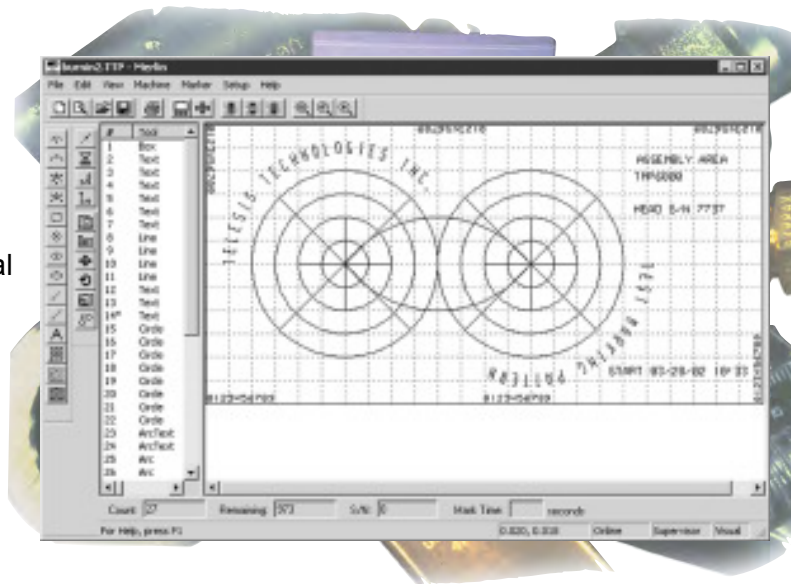

Marking "tools" available include text (at any angle), arc text, rectangles, circles, ellipses and lines.

Multiple fields can be grouped and saved as a block to form a logo, or import logos via DXF CAD files.

Non-printable fields clearly show the graphical representation of the part being marked. Use the convenient, "GO TO" command to avoid obstacles within the marking window.

The TMP1700/470 is the lowest cost PINSTAMP® Marking System. The rugged TMP1700 marking head features a compact, 1-1/2" x 2-1/2" (38.1 x 63.5mm) window, and marking speeds up to six characters per second. It's an excellent choice for many factory-automated or on-line processes.

FEATURES

- 1-1/2" x 2-1/2" (38.1 x 63.5mm) Marking Window
- Rugged, low-maintenance X/Y platform
- Compact Marking Head — approximately 6.6" x 6.2" x 4.7" (168 x 158 x 120mm)
- Marks a wide range of materials from soft plastics to hardened steel — up to Rc60
- Shutter assembly protects marking head from solid and liquid contaminants
- Self-Contained, state-of-the-art TMC470 controller features two serial ports, USB port and ethernet port. (see page 21)
- Dot density up to 200 dots per inch (79 per centimeter)
- Choice of Interchangeable Marking Pin Types for depths from .001" - .018" (.03 - .45mm)
- Pin travel accommodates surface irregularities to .25" (6mm)
- Automatically generates serial numbers, time, date and shift codes
- Stores up to 200 marking patterns
- Easily interfaced to PLCs (Programmable Logic Controllers) and Host Computers

OPTIONAL ACCESSORIES

- Rotary fixtures for marking circumferences of cylindrical parts
- Marking head mounting post including programmable Z-axis version
- Panel-mount and IP/NEMA Rated Controllers
- Logo/Font design software package for design of custom fonts or logos
- PC-Based Upgrade Utility available FREE from www.telesis.com for easy software upgrade
- Powerful Windows based **Merlin® III** Software available third quarter 2009. (See page 21)

Compact Self-Contained
TMC470 Controller



A protective shutter assembly shields the TMP1700 marking head from liquid and solid contaminants.



The TMP1700/420 contains Data Matrix® 2-D code marking capability, meeting all US Department of Defense UID requirements and other industry standards.

The TMP4210/420 is an extremely lightweight, hand-held, single pin marker satisfying a wide range of portable marking applications. Its robust rack-and-pinion design and compact envelope also make it the right choice for many high production, on-line applications.



FEATURES

- Simple, Easy to Use Single Pin Design
- Compact and Ergonomic; Weighs about 2.0kg (4.4 pounds)
- Available with 25S or 150SA Marking Pin
- 50 x 13mm (2" x .5") Marking Window
- Economically Priced
- Marks up to 3.5 3mm (1/8") High Characters per Second
- Utilizes Same Rugged Rack-and-Pinion X/Y Platform as Field-Proven TMM4200
- Detachable Electronics Cable for Improved Serviceability
- Teamed with Reliable, Self-Contained TMC420 Controller (see page 25)
- Also Available Without Handle and Stand-Off for Fixtured Applications

OPTIONAL ACCESSORIES

- Panel-mount and IP/NEMA rated controllers
- Debris Shield Kit protects from solid contaminants
- Cable Balancer Attachment Bracket
- Marking Head Standoff V-Block kit for Marking the Circumference of Cylindrical Parts
- Quick Disconnect Tool Post
- Bar Code Scanner for automatic data entry
- Logo-Font design software package for design of custom fonts or logos
- PC-Based Upgrade Utility available FREE from www.telesis.com for easy software upgrade
- PC-Based Pattern (marking file) Back-up Utility available FREE from www.telesis.com



Compact TMC420 Controller features 4-line LCD Display — no PC required.



The TMP4210/420 contains Data Matrix® 2-D code marking capability, meeting all US Department of Defense UID requirements and other industry standards.

The TMP3200/470 Single Pin Marking System features a large 4" x 6" (100 x 150mm) marking window, and marking speeds up to six characters per second. Well suited for both bench top and factory-automated applications, its simple, yet robust belt-driven dual rail, X/Y platform yields high quality characters and low maintenance operation.



FEATURES

- 4" x 6" (100 x 150mm) Marking Window
- Belt-driven, dual rail X/Y mechanism with superior wear characteristics
- Patented floating pin technology accommodates surface irregularities of up to .25" (6mm)
- Marks a wide range of materials from soft plastics to hardened steel — up to Rc60
- Choice of pin sizes for marking depths from .001" - .018" (.03 - .45mm)
- Self-contained, state-of-the-art TMC470 controller features two serial ports, USB port and Ethernet port (see page 21)
- Automatically generates serial numbers, date, time and shift codes
- Stores up to 200 marking patterns
- Easily interfaced to PLCs (Programmable Logic Controllers) and Host Computers
- Dot density up to 200 dots per inch (79 per centimeter)

OPTIONAL ACCESSORIES

- Rotary fixtures for marking circumferences of cylindrical parts
- Marking head mounting post including programmable Z-axis version
- Panel-mount and IP/NEMA-Rated Controllers
- Logo/Font design software package for design of custom fonts or logos
- PC-Based Upgrade Utility available FREE from www.telesis.com for easy software upgrade
- Powerful Windows based Merlin® III software available third quarter 2009. (see page 21)



A protective shutter assembly shields the TMP3200 marking head from liquid and solid contaminants.



Compact Self-Contained TMC470 Controller



The TMP3200/470 contains Data Matrix® 2-D code marking capability, meeting all US Department of Defense UID requirements and other industry standards.

The TMC420 is a versatile, compact system controller that can be used with a wide range of Telesis Marking Heads. The TMC420 is fully self-contained and requires no Personal Computer. Other features include a 4-line LCD display and rugged rubber keyboard. With an RS232/485 serial port and eight discrete inputs/outputs, the TMC420 is easily integrated with factory automated applications.



The TMC420P is a panel-mount version designed specifically for mounting in industrial enclosures.



The TMC420N is a NEMA 12 (IP55) rated version for wall mounting or table top use.

FEATURES

- No PC required
- Three standard character fonts
- Automatic serialization, date coding and shift coding
- Four-line LCD display and rugged, sealed keyboard
- User-friendly pattern design software and prompted, interactive data entry
- Stores up to 75 marking patterns
- Extremely compact 12-1/2" W x 8" D x 2.8" H (317 x 203 x 71mm) envelope
- 12-24 VDC "Start Print," "Abort," "Ready" and "Done" I/O signals
- Up to 15 different marking patterns remotely selectable via 12-24 VDC discrete inputs
- RS232 Host/Scanner Interface to download text to individual fields or call up entire patterns
- Up to 31 controllers can be networked to a single host
- "Start Print" and "Abort Print" signals from a simple contact closure
- Operates on 100-130 VAC or 200-250 VAC, 50-60 Hz power
- Conforms to all European Community (CE) norms
- Flash memory and PC-based software utility provide for software upgrades without Eprom change
- Optional PC-based Logo-Font Design Software allows user-defined fonts or logos to be created in a PC, then downloaded to the TMC420
- Available with TMP3200, TMM4200, TMM4250, TMP4210, TMM4215, TMM5100, TMM5400, TMM7200, SC3500, and SC5000 Marking Heads.

Equipped with eight marking pins, the TMM5400/420 is the fastest dot peen marker available. Its speed and its compact envelope make it the perfect solution for many on-line, high-speed marking applications.



FEATURES

- Marks up to 16 Characters per Second
- Marking windows as large as .5" x 3.78" (13 x 96mm)
- Two marking pin cartridge configurations available to optimize marking window size/cycle time combinations
- Extremely compact marking head for easy integration into factory-automated applications
- Marks a wide range of materials from soft plastics to hardened steel — up to Rc60
- Telesis' patented "Floating Pin" technology accommodates surface irregularities up to .25" (6mm)
- Compact, convenient TMC420 Controller with rubber keyboard and 4-line LCD display — no PC required (see page 25)
- Automatically generates serial numbers, date, time and shift codes
- Easily interfaced to PLCs (Programmable Logic Controllers) and Host Computers
- Stores up to 75 marking patterns

OPTIONAL ACCESSORIES

- Panel-mount and IP/NEMA-Rated Controllers (see page 25)
- Logo/Font design software package for design of custom fonts or logos
- PC-Based Upgrade Utility available FREE from www.telesis.com for easy software upgrade
- PC-Based Pattern Back-up Utility available FREE from www.telesis.com



Compact TMC420 Controller features 4-line LCD Display — no PC required.



The TMM5400/420 contains Data Matrix® 2-D code marking capability, meeting all US Department of Defense UID requirements and other industry standards.

The unique TMM4200 Multiple Pin Marking Head can be equipped with up to four marking pins for very high speed marking, yet weighs only 4.5 pounds (2.0kg). Its light weight, compact ergonomic design, plus optional pistol-grip handle make the TMM4200 the ultimate hand-held permanent marker.

FEATURES

- Compact, Ergonomic Design
- Weighs 4.5 pounds (2.0kg)
- Available with four 25S or two 150SA Marking Pins
- Marks up to eight .125" (3mm) high Characters per Second
- Marking Windows up to 0.5" x 2" (13 x 50mm)
- Depths up to 0.013" (.33mm) in Mild Steel
- Rugged Rack-and-Pinion X/Y Platform for low maintenance operation
- Simple Shutter Plate Protects Head from Solid and Liquid Contaminants
- Detachable Electronics Cable for Improved Serviceability
- Self-contained, state-of-the-art TMC470 controller features two serial ports, USB port and Ethernet port (see page 21)
- Also Available Without Handle and Stand-Off for Fixtured Applications
- Automatically generates serial numbers, date, time and shift codes
- Stores up to 200 Marking Patterns
- Easily interfaced to PLCs (Programmable Logic Controllers) and Host Computers



OPTIONAL ACCESSORIES

- Panel-mount and IP/NEMA-Rated Controllers (see page 21)
- Quick Disconnect Tool Post
- Logo/Font design software package for design of custom fonts or logos
- PC-Based Upgrade Utility available FREE from www.telesis.com for easy software upgrade

Compact Self-Contained TMC470 Controller



The TMM4200/470 contains Data Matrix® 2-D code marking capability, meeting all US Department of Defense UID requirements and other industry standards.

The innovative dual-pin TMM4215 provides a 4" x 0.5" (100 x 13mm) marking window, twice as large as that of the TMM4200. This lightweight, compact marker is available in both fixtured and hand-held configurations.

FEATURES

- Compact, ergonomic design
- Weighs 4.5 pounds (2.0kg)
- Marks up to four .125" (3mm) high characters per second
- Available with the high-speed 25S marking pin or the deep marking 150SA pin
- Marking depths up to 0.013"(.33mm) in Mild Steel
- Rugged Rack and Pinion X/Y Platform for low maintenance operation
- Also available without handle and standoff for fixtured applications
- Detachable Electronics cable for improved serviceability
- Compact, convenient TMC420 controller with rubber keyboard and 4-line LCD display - no PC required (see page 25)
- Automatically generates serial number, time, date and shift codes
- Stores up to 75 marking patterns
- Easily interfaced to PLC's (Programmable Logic Controllers) and host computers

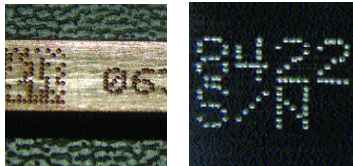

OPTIONAL ACCESSORIES

- Panel-mount and IP/NEMA rated controllers (see page 25)
- Cable balancer attachment kit
- Marking head standoff V-Block Kit for marking on the circumference of cylindrical parts
- Quick-disconnect tool post
- Bar code scanner for automatic data entry
- Logo-Font Design Software package for design of custom fonts or logos
- PC-based upgrade utility available FREE from www.telesis.com for easy software upgrade
- PC-based Pattern (marking file) Back-up utility available FREE from www.telesis.com

Shown with optional debris shield



The TMM4215/420 contains Data Matrix® 2-D code marking capability, meeting all US Department of Defense UID requirements and other industry standards.

The TMM4250/470 Multiple Pin Marking System can mark up to eight characters per second. It is ideal for many on-line applications with severe spatial constraints — or in wet or dirty environments. The TMM4250 Marking Head features an extremely compact envelope and provides marking windows up to 0.5" x 2" (13 x 50mm). It can be easily integrated within a wide range of manufacturing settings. A NEMA 12 (IP55) enclosure with industrial grade, protective rubber “boot” makes it highly resistant to both solid and liquid contaminants, including machine tool coolants.



OPTIONAL ACCESSORIES

- Panel-mount and IP/NEMA-Rated Controllers
- Logo/Font design software package for design of custom fonts or logos
- PC-Based Upgrade Utility available FREE from www.telesis.com for easy software upgrade
- PC-Based Pattern Back-up Utility available FREE from www.telesis.com



FEATURES

- NEMA 12-Rated (IP55) with Rubber Boot for Protection Against Solid and Liquid Contaminants
- Extremely Compact for Ease of Integration
- Available with four 25S or two 150SA Marking Pins
- Marks up to eight .125" (3mm) high Characters per Second
- Self-contained, state-of-the-art TMC470 controller features two serial ports, USB port and Ethernet port (see page 21)
- Stores up to 200 marking patterns
- Marking Windows up to 0.5" x 2" (13 x 50mm)
- Depths up to 0.013" (.33mm) in Mild Steel
- Rugged Rack-and-Pinion X/Y Platform for low maintenance operation
- Detachable Electronics Cable for Improved Serviceability
- RS232 or TCPIP Host interface to download text to individual fields or call up entire patterns
- Automatically generates serial numbers, date, time and shift codes
- Easily interfaced to PLCs (Programmable Logic Controllers) and Host Computers

Compact Self-Contained TMC470 Controller



The TMM4250/470 contains Data Matrix® 2-D code marking capability, meeting all US Department of Defense UID requirements and other industry standards.

Mark up to six characters/second with the TMM5100/420 Multiple Pin Marking System. Its lightweight, compact design and minimal footprint are ideal for hand-held, stand-alone or completely integrated, factory automated operations. A variety of pin sizes/configurations are available to mark character heights from .04" - .63" (1 - 16mm) on a wide range of materials.



FEATURES

- High speed — up to six pins marking simultaneously
- Marking windows up to .625" x 4.5" (16 x 114mm)
- Marks a wide range of materials from soft plastics to hardened steel — up to Rc60
- Available with a variety of marking pin cartridge configurations for optimal combination of character size, marking depth, marking window size and cycle time
- Compact, rugged X/Y positioning mechanism
- The right choice for many VIN (Vehicle Identification Number) Marking Applications
- Compact, convenient TMC420 Controller with rubber keyboard and 4-line LCD display — no PC required (see page 25)
- Automatically generates serial numbers, time, date and shift codes
- Stores up to 75 marking patterns
- Easily interfaced to PLCs (Programmable Logic Controllers) and Host Computers
- Pin travel accommodates surface irregularities to .25" (6mm)

OPTIONAL ACCESSORIES

- Panel-mount and IP/NEMA-Rated Controllers (see page 25)
- Marking head support tooling and balancers
- Logo/Font design software package for design of custom fonts or logos
- PC-Based Upgrade Utility available FREE from www.telesis.com for easy software upgrade
- PC-Based Pattern Back-up Utility available FREE from www.telesis.com



Compact TMC420 Controller features 4-line LCD Display — no PC required.

The TMP7000/420 is a robust single pin marker targeted at applications requiring extremely deep penetration marking. Its 4" x 6" (100 x 150mm) marking window is ample for a wide range of applications and its TMC420 controller allows it to be easily integrated into most automated applications.



"We recommend Telesis hardware to our clients because we believe it is the best marking equipment available. The success of our software business depends on high quality 2D Data Matrix™ dot peen marks and Telesis consistently delivers quality marks – every day – every time!"

Chuck Stewart, Stewart Technologies Inc.

FEATURES

- Great for marking large characters and/or rough surfaces
- Large 4" x 6" (100 x 150mm) marking window
- Marks up to 0.025" (.63mm) deep in mild steel
- Compact, convenient TMC420 Controller with rubber keyboard and 4-line LCD display — no PC required (see page 25)
- Automatically generates serial numbers, date, time and shift codes
- Marks a wide range of materials from soft plastics up to hardened steel
- Stores up to 75 marking patterns

OPTIONAL ACCESSORIES

- Panel-mount and IP/NEMA-Rated Controllers (see page 25)
- Marking head support tooling and balancers
- Logo/Font design software package for design of custom fonts or logos
- PC-Based Upgrade Utility available FREE from www.telesis.com for easy software upgrade
- PC-Based Pattern Back-up Utility available FREE from www.telesis.com



Compact TMC420 Controller features 4-line LCD Display — no PC required.

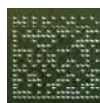

The TMM4250/420 contains Data Matrix® 2-D code marking capability, meeting all US Department of Defense UID requirements and other industry standards.

The TMM7200 is an extremely heavy duty multiple pin marking system configured on a “per project” basis to provide optimum solutions for individual applications. The TMM7200 is the right choice for the deep penetration marking required for large character sizes, or when marking especially rough surfaces. The flexible TMM7200 can be equipped with up to 21 marking pins, allowing it to print 21 characters in 1.5 seconds. In addition, marking pins can be located on varying horizontal and vertical center distances from .25” (6mm) to 1.75” (44.5mm) to provide a wide range of very large marking windows.

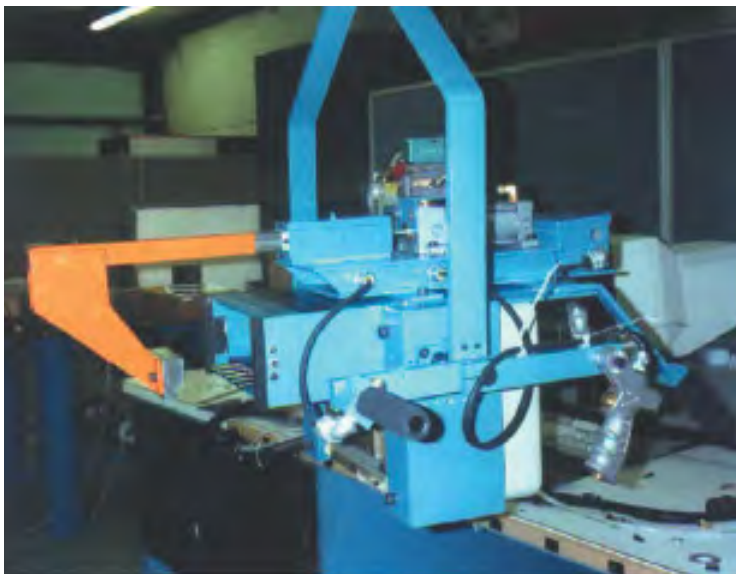

The TMM7200 is easily adapted to custom designs and fixturing options.

Virtually silent, the economical SC3500/420 inscribes high quality, continuous line characters in most metals and plastics. It is well suited for a wide range of automated on-line and stand-alone bench top applications.



FEATURES

- Extremely low noise marking
- Durable, heavy duty marking head provides large 4" x 6" (100 x 150mm) marking window
- Economically priced Scribe Marker, well suited for a wide range of automated on-line and stand-alone Bench Top applications
- Compact, convenient TMC420 Controller with rubber keyboard and 4-line LCD display — no PC required (see page 25)
- Automatically generates serial numbers, date, time and shift codes
- Easily interfaced to PLCs (Programmable Logic Controllers) and Host Computers
- Marks a wide range of materials from soft plastics up to hardened steel
- Stores up to 75 marking patterns

OPTIONAL ACCESSORIES

- Marking head mounting post with base
- Panel-mount and IP/NEMA-Rated Controllers (see page 25)
- Marking head support tooling and balancers
- Logo/Font design software package for design of custom fonts or logos
- PC-Based Upgrade Utility available FREE from www.telesis.com for easy software upgrade
- PC-Based Pattern Back-up Utility available FREE from www.telesis.com



Compact TMC420 Controller features 4-line LCD Display — no PC required.



The powerful, extremely heavy-duty SC5000/420 is the right choice when deep, low noise marking is required. It is especially well-suited for VIN (Vehicle Identification Number) marking applications.



FEATURES

- Extremely low noise marking
- Powerful, rugged marking head drive mechanism for deep scribe marking
- 2½" x 7½" (63.5 x 190.5mm) marking window
- Especially well suited for VIN (Vehicle Identification Number) applications
- Compact, convenient TMC420 Controller with rubber keyboard and 4-line LCD display — no PC required (see page 25)
- Automatically generates serial numbers, date, time and shift codes
- Easily interfaced to PLCs (Programmable Logic Controllers) and Host Computers
- Marks a wide range of materials from soft plastics up to hardened steel
- Stores up to 75 marking patterns

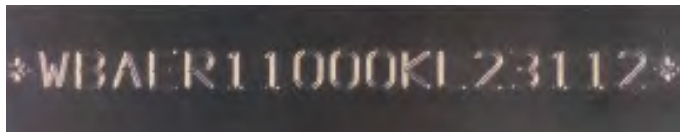

OPTIONAL ACCESSORIES

- Marking head support tooling and balancers
- Panel-mount and IP/NEMA-Rated Controllers (see page 25)
- Logo/Font design software package for design of custom fonts or logos
- PC-Based Upgrade Utility available FREE from www.telesis.com for easy software upgrade
- PC-Based Pattern Back-up Utility available FREE from www.telesis.com
- Optional SS5500/420 Servo Motor Driven Versions Available For High Speed Applications

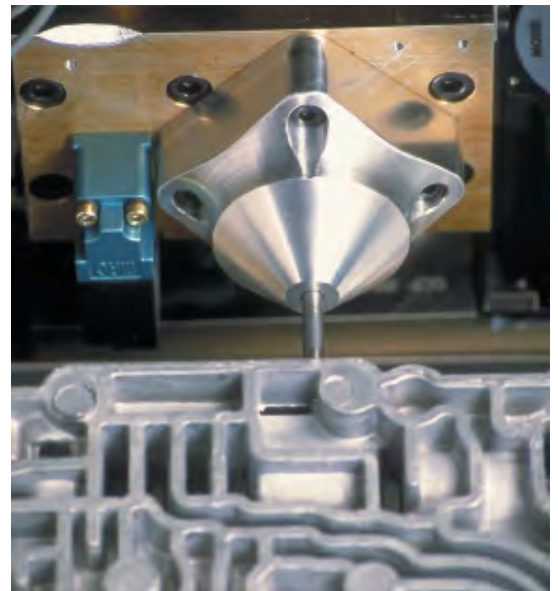

Compact TMC420 Controller
features 4-line LCD Display — no PC required.

The **BenchMark**® 460 is a fully programmable, cost effective alternative to old-fashioned permanent marking techniques for parts too large or heavy to be carried to a marking station. Its hand-held marking head is lightweight and ergonomically designed, while providing a generous 25 x 100mm (1" x 4") marking window. An electromechanical marking pin eliminates the need for any air supply, making the **BenchMark**® 460 truly portable.



FEATURES

- Compact, ergonomic marking head weighs only 1.7 kg (3.75 pounds)
- Generous 25 x 100mm (1" x 4") marking window
- High quality, permanent, programmable marking on a wide range of materials — from soft plastics to hard metals up to Rc60
- No consumables
- Electromechanical marking pin eliminates the need for air supply
- Marks up to 5 characters per second
- Automatically generates serial numbers, as well as date, time and shift codes



OPTIONAL ACCESSORIES

- Bar Code Scanner for automatic data entry
- Logo-Font design software package for design of custom fonts or logos
- PC-Based Upgrade Utility available FREE from www.telesis.com for easy software upgrade
- PC-Based Pattern (marking file) Back-up Utility available FREE from www.telesis.com



Compact, BenchMark® Controller with rubber keyboard features 4-line LCD Display — no PC required

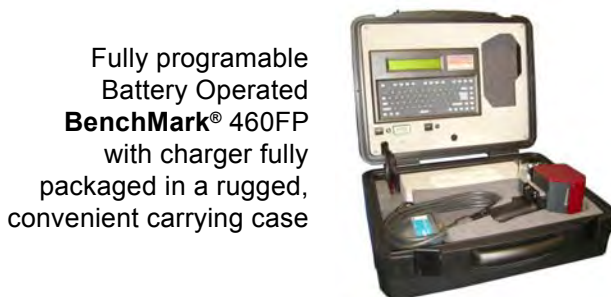

Fully programable
Battery Operated
BenchMark® 460FP
with charger fully
packaged in a rugged,
convenient carrying case



Features DATA MATRIX™ 2-D Code Marking Capability — Meets all Department of Defense UID Requirements

The **BenchMark® 320** is an extremely versatile yet economically priced benchtop marking system. It offers a generous 4" x 6" (100 x 150mm) marking window large enough to satisfy almost any application. And its unique marking arm design is extremely convenient for parts loading and unloading as well as marking pattern design. The system is self-contained with compact controller and rugged extruded aluminum mounting post and base.

"I want to thank Telesis for manufacturing a product that performs as well in real life as it states in your literature.

Our new BenchMark® 320 Marking System from Telesis has performed above our expectations since putting it into service. The BenchMark® 320 greatly simplified our identification tag printing process and provided Krispy Kreme with "just in time" tag production capabilities. If you are looking for high quality, flexibility and reliability in permanent marking equipment, Telesis has the solution."

Jeff Renz, Krispy Kreme



FEATURES

- High quality, permanent, programmable marking on a wide range of materials — from soft plastics to hard metals up to Rc60
- Large 4" x 6" (100 x 150mm) marking window
- Marking arm allows clear access for loading and unloading of parts
- Electromechanical marking pin eliminates the need for air supply
- Marks up to 5 characters per second
- Automatically generates serial numbers, as well as date, time and shift codes
- Compact, convenient controller with 4-line LCD display and rubber keyboard- no PC required

OPTIONAL ACCESSORIES

- Rotary fixture for marking circumferences of cylindrical parts
- Bar Code Scanner for automatic data entry
- Start-Print footswitch and pushbutton station
- Logo/Font design software package for design of custom fonts or logos
- PC-Based Upgrade Utility available FREE from www.telesis.com for easy software upgrade
- PC-Based Pattern Back-up Utility available FREE from www.telesis.com
- **Benchmark® 320+** version with enhanced communications capabilities



Features DATA MATRIX™ 2-D Code Marking Capability — Meets all Department of Defense UID Requirements

The **BenchMark® 200** is an extremely economical, fully programmable alternative to old-fashioned permanent marking techniques. This complete system, with self-contained controller and extruded aluminum marking head mounting post and base, is the right choice for many stand-alone bench top marking applications. An electromechanical marking pin eliminates the need for any air supply, making it easy to move the **BenchMark® 200** from one work area to another.



FEATURES

- Extremely affordable
- High quality, permanent, programmable marking on a wide range of materials — from soft plastics to hard metals up to Rc60
- Ample 4" x 4" (100 x 100mm) marking window
- Electromechanical marking pin eliminates the need for air supply
- Marks up to 5 characters per second
- Automatically generates serial numbers, as well as date, time and shift codes
- Compact, convenient controller with rubber keyboard and 4-line LCD display — no PC required

OPTIONAL ACCESSORIES

- Rotary fixture for marking circumferences of cylindrical parts
- Bar Code Scanner for automatic data entry
- Start-Print footswitch and pushbutton station
- Logo/Font design software package for design of custom fonts or logos
- PC-Based Upgrade Utility available FREE from www.telesis.com for easy software upgrade
- PC-Based Pattern Back-up Utility available FREE from www.telesis.com
- **Benchmark® 200+** version with enhanced communications capabilities

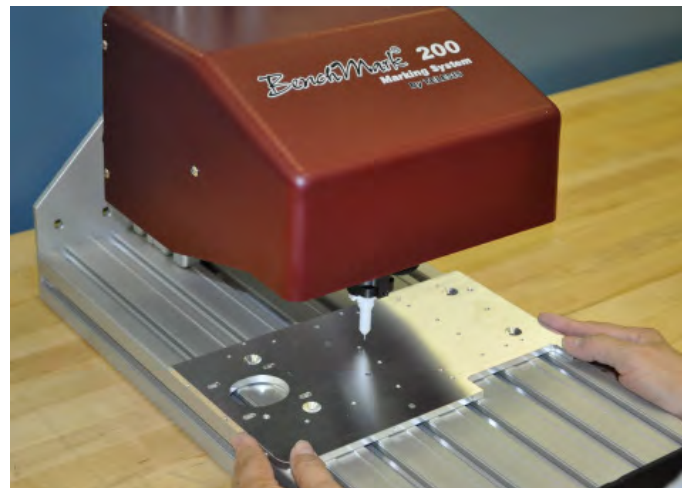

Features DATA MATRIX™ 2-D Code Marking Capability — Meets all Department of Defense UID Requirements

Choose from a variety of accessories to enhance your Telesis Pin Marking System. All are tested for compatibility and carry a one-year limited warranty. Ask your Telesis Sales Representative about the options best suited for your application.

Rotary Fixtures

For easy circumferential marking

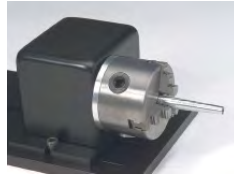

Marking Head Gimbals, Stand-offs and Cable Balancers

For flexible, virtually weightless, hand-held marking



Bar Code Scanners and Wands

Eliminate manual data entry

Manual Push Button Stations and Foot Switches

For manual control of on-line automated marking stations and remote start control



A variety of Industrial Controller Enclosures are Available

Protect control components from harsh environments. Several wall and floor-mount styles/ colors available



Four Wheeled Carts

For portable applications



Marking Head Mounting Posts

With manual, pneumatic or stepper motor-driven head positioning mechanisms



In addition, Telesis offers expert integration of our entire range of pin marking systems, including software, hardware and control system design services. Whether it's a stand-alone manual marking station or a fully automated on-line factory-integrated application, Telesis can provide a complete solution to your marking system requirements.



Manufacturers are increasingly turning to the use of 2-D code direct part marking (DPM) and reading technologies. DPM reduces costs, improves quality, and satisfies a number of industry-specific and government mandates, including U.S. Department of Defense UID (Universal Identification) requirements. Successful implementation requires the integration of robust, industrial marking systems with 2-D code verifiers located at the marking station. Together, they insure the ability to easily read and track the 2-D code.

Telesis' extensive experience in the automotive, aerospace and firearms industries makes us uniquely qualified to provide, completely integrated, "mark-read" solutions. We offer the following products and services to satisfy a wide range of 2-D code applications:

- Telesis' PINSTAMP® Dot Peen Marking Systems
- Telesis' Laser Marking Systems
- Expert integration of these Telesis products, as well as the integration of 2-D code verifiers marketed by a number of suppliers

PINSTAMP® Markers provide an effective but extremely economical solution to many 2-D code DPM applications on materials as diverse as plastics and hardened steel. Telesis' patented **PINSTAMP®** Marking Technology provides highly accurate dot placement at specific X/Y locations. This process makes PINSTAMP® Markers far superior to conventional "oscillating stylus" dot peen markers, especially in 2-D code applications, where accurately marked codes are the key to readability.

TELESIS Lasers are truly "state-of-the-art", producing almost perfectly formed 2-D codes nearly instantly on a wide range of materials, including virtually all plastics and metals. These qualities make lasers the perfect choice for applications requiring extremely high throughput or very small 2-D codes.

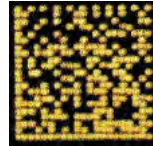

COMPLIANCE

All TELESIS LASERS and all PINSTAMP® Markers except for the TMM5100/420 and TMM7200 comply with all major 2-D code DPM standards, including:

- SAE AS9132 (as adopted by the International Aerospace Quality Group)
- AIAG B-4
- AIAG B-17
- NASA-STD-6002
- NASA-STD-HDBK-6003
- Department of Defense Guide to Uniquely Identifying Items (UID)
- MIL-STD-130N

PIN STYLE	CONE ANGLES	MATERIALS*	LENGTH	MAJOR DIAMETER	MINOR DIAMETER
10MP	30° 45°	Carbide	0.62" 16mm	0.09" 2.3mm	0.04" 1.0mm
25S	22° 30° 45° 60°	Carbide, Powdered Metal	1.8" 45mm	0.19" 4.8mm	0.09" 2.4mm
25L	22.5° 30° 45° 60°	Carbide, Powdered Metal	2.2" 55mm	0.19" 4.7mm	0.09" 2.4mm
25XL	22.5° 30° 45° 60°	Carbide, Powdered Metal	2.5" 64mm	0.19" 4.7mm	0.09" 2.4mm
25XLE	30° 45°	Carbide	1.8" 46mm	0.16" 4.0mm	0.09" 2.4mm
101	30° 45° 60°	Carbide, Powdered Metal	3.9" 99mm	0.31" 7.9mm	0.15" 3.9mm
150S	30° 45° 60°	Powdered Metal, Carbide-Tipped	2.75" 70mm	0.62" 15.7mm	0.37" 9.5mm
150SA	30° 45°	Carbide-Tipped	2.75" 70mm	0.62" 15.7mm	0.37" 9.5mm
150	30°	Powdered Metal	5.25"	0.62"	0.37"
150	45°		133.4mm	15.7mm	9.5mm



*Carbide = Tungsten Carbide (Hardness approximately 92 Rockwell A),
Powdered Metal (Hardness 63 – 65 Rockwell C).
**Varies with material hardness, cone angle and marking head

MARKERS	APPLICATIONS	NOMINAL STROKE LENGTH	TYPICAL MAX DEPTH OF MARK**
TMP1700, TMM4200, TMM5400	Great for high resolution graphics and 2-D codes with multi-pixel cells. Pneumatically driven. Light marking in plastic or soft metals. Extremely fast marking, especially in multi-pin markers.	0.14" 3.5mm	0.001 – 0.003" 0.02mm
TMP4210, TMM5400, TMP3200, TMM4200, TMM4215, TMM4250	Very fast, limited penetration marking. For marking small characters on relatively smooth surfaces. Pneumatically driven.	0.38" 9.6mm	0.0025 – 0.011" 0.06 – 0.28mm
TMP6100, TMM5100, TMP1700, TMP3200, TMM7200	Fast, limited penetration marking. For marking small characters on relatively smooth surfaces. Pneumatically driven.	0.50" 12.7mm	0.0025 – 0.016" 0.06 – 0.40mm
TMP6100, TMM5100, TMM7200, TMP1700, TMP3200, DPP2000	Similar to 25L. Extra length for recessed or hard to reach marking surfaces. Pneumatically driven.	0.50" 12.7mm	0.0025 – 0.016" 0.06 – 0.40mm
TMP1700, TMP3200, TMP6100, Benchmark® 200, Benchmark®320, Benchmark® 460	Fast, limited penetration marking. For marking small characters on relatively smooth surfaces. Electrically driven.	0.15" 3.8mm	0.0025 – 0.011" 0.06 – 0.28mm
TMM5100, TMM7200	For deep marks, large dots and characters, and/or rough surfaces. Pneumatically driven.	0.75" 19mm	0.006 – 0.022" 0.15 – 0.56mm
TMP6100, TMM5100, TMM7200, TMP1700	Similar to 101. High speed marking. Pneumatically driven.	0.25" 6.35mm	0.006 – 0.022" 0.15 – 0.56mm
TMP6100, TMP3200, TMM4200, TMM4215, TMP4210, TMM4250, TMM7200, TMP1700	Similar to 150S.	0.75" 19mm	0.006 – 0.022" 0.15 – 0.56mm
TMM7200, TMP7000	Very heavy duty, deep penetration, large character marking; and/or very rough surfaces such as castings and mill surfaces. Pneumatically driven.	1.00" 25.4mm	0.020 – 0.030" 0.51 – 0.76mm

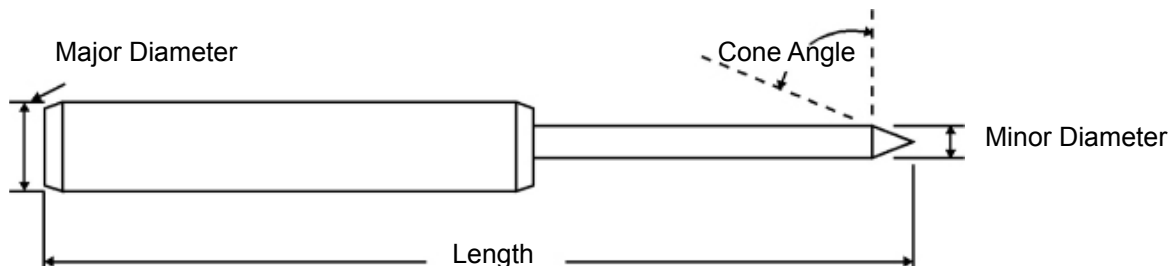

FEATURES	TMP6100	TMM5100	TMP3200	TMM7000	TMM7200	TMM4200/4215	TMP4210
	Versatile Tabletop Marker for Batch Processes/Job Lots or On-Line Processes	Rapid, On-Line, Hand-Held, or Automated Marking, VIN Numbers	Cost-Effective On-Line High Speed Marking	Heavy-Duty, Large Character, Deep Penetration Marking	Heavy-Duty, Large Character, Deep Penetration Marking	High Speed Lightweight, Hand-Held Marking or Fixtured Applications with Severe Spatial Constraints	Hand-Held Marking or Fixtured Applications with Severe Spatial Constraints
Controller	TMC470	TMC420	TMC470	TMC420	Various	TMC470	TMC420
Hand-Held Applications		•	Consult Factory	Consult Factory	•	•	Yes
Mark Depth (Based on Rb53 Material Hardness)	0.001-0.013 in. (.03-.33mm)	0.001-0.013 in. (.03-.33mm)	0.001-0.013 in. (.03-.33mm)	0.001-0.022 in. (.03-.56mm)	0.001-0.010 in. (.03-.25mm)	0.001-0.010 in. (.03-.25mm)	0.001-0.013 in. (.03-.33mm)
Noise Level	Moderate	Moderate	Moderate	Moderate	Moderate	Moderate	Moderate
Computer Required	No	No	No	No	No	No	No
PS-OCR Readable Fonts	•	•	•	•	•	•	•
Marking Speed - MAX	Up to 3 Char./Sec.	Up to 6 Char./Sec.	Up to 6 Char./Sec.	Up to 2 Char./Sec.	Up to 21 Char./ 1.5 sec.	4200-Up to 8 Char./Sec. 4215-Up to 4 Char/Sec	Up to 8 Char./Sec.
Maximum Marking Window Size	6 x 12 in. (152 x 304mm)	0.625 x 4.5 in. (16 x 114mm)	4 x 6 in. (100 x 150mm)	4 x 6 in. (100 x 150mm)	64 sq. in. (413 sq. mm)	0.50 x 4.00 in. (13x 100mm)	0.50 x 2.00 in. (13x 50mm)
Maximum Character Height	6.0 in. (152mm)	0.63 in. (16mm)	4 in. (100mm)	4 in. (100mm)	1.75 in. (44.5mm)	0.50 in. (13mm)	0.50 in. 13mm
Programmable "Z" Axis	Optional		Optional				
Maximum No. of Pins	1	6	1	1	21	4200- 4 / 4215- 2	1
Multiple Line Marking	•	•	•	•	•	•	•
Arc Text	Yes	Yes	Yes	Yes	Custom Software	No	No
Continuous Characters	•	•	•	•	•		•
Logos	Yes	Optional Software	Optional S.W./Yes	Custom Software	Custom Software	Optional Software	Optional Software
2-D Codes	Yes		Yes	Yes	Yes	Yes	Yes
Serialization	•	•	•	•	•	•	•
Date Codes	•	•	•	•	•	•	•
Surface Irregularities	Up to 0.25" (6mm)	Up to 0.25" (6mm)	Up to 0.25" (6mm)	Up to 0.25" (6mm)	Up to 0.25" (6mm)	Up to 0.25" (6mm)	Up to 0.25" (6mm)
Number of Std. Fonts	3	3	3	3	3	3	3
User Defined Custom Fonts	Optional Software	Optional Software	Optional Software	Optional Software	Optional Software	Optional Software	Optional Software
Host Interface	Yes	Yes	Yes	Yes	Yes	Yes	Yes
Resolution	Up to 200 dpi (79 d/cm)	Up to 200 dpi (79 d/cm)	Up to 200 dpi (79 d/cm)	Up to 200 dpi (79 d/cm)	Up to 200 dpi (79 d/cm)	Up to 200 dpi (79 d/cm)	Up to 200 dpi (79 d/cm)
Power	115 or 220 VAC	115 or 220 VAC	115 or 220 VAC	115 or 220 VAC	115 or 220 VAC	115 or 220 VAC	115 or 220 VAC
Air Supply	60-100 PSIG (4.1-6.9 Bars)	60-100 PSIG (4.1-6.9 Bars)	60-100 PSIG (4.1-6.9 Bars)	60-100 PSIG (4.1-6.9 Bars)	60-100 PSIG (4.1-6.9 Bars)	60-100 PSIG (4.1-6.9 Bars)	60-100 PSIG (4.1-6.9 Bars)
Circumferential Marking	Optional		Optional				

TMM4250	TMP1700	TMM5400	SC3500	SC5000	BenchMark®200	BenchMark®320	BenchMark®460
Fixtured Applications in Wet or Dirty Environments	Extremely Cost-Effective On-Line, High Speed Marking	8-Pin Marking Head for Extremely High Speed On-Line Applications	Nearly Silent, Moderate Penetration Scribe Marking	Nearly Silent, Deep Penetration Scribe Marking	Stand-Alone Benchtop Applications	Stand-Alone Benchtop Applications	Stand-Alone Hand-Held Applications
TMC470	TMC470	TMC420	TMC420	TMC420	Benchmark®	Benchmark®	Benchmark®
	Consult Factory	Consult Factory	Consult Factory	Consult Factory			Yes
0.001-0.013 (.03-.33mm)	0.001-0.013in. (.03-.33mm)	0.001-0.010 in. (.03-.25mm)	Varies	Varies	0.001-0.010 in (.03-.25mm)	0.001-0.010 in (.03-.25mm)	0.001-0.010 in. (.03-.25mm)
Moderate	Moderate	Moderate	Very Low	Very Low	Moderate	Moderate	Moderate
No	No	No	No	No	No	No	No
•	•	•	•	•	•	•	•
Up to 8 Char/Sec	Up to 6 Char/Sec	Up to 32 Char. in 2 Seconds	Up to 2 Char./Sec.	Up to 2 Char./Sec.	Up to 5 Char./Sec.	Up to 5 Char./Sec.	Up to 5 Char./Sec.
0.50 x 2.00 in. (13 x 50mm)	1.50 x 2.50 in. (38.1 x 63.5mm)	0.5 x 3.78 in. (12.7 x 96mm)	4 x 6 in. (100 x 150mm)	2.5 x 7.5 in. (63.5 x 190.5mm)	4 x 4 in. (100 x 100mm)	4 x 6 in. (100 x 150mm)	1 x 4 in. (25 x 100mm)
0.50 in. (13mm)	1.50 in. (38.1mm)	0.5 in. (12.7mm)	4 in. (100mm)	2.5 in. (63.5mm)	4 in. (100mm)	4 in. (100mm)	1 in. (25mm)
	Optional						
4	1	8	1	1	1	1	1
•	•	•	•	•	•	•	•
No	Yes	No	Yes	Yes	Yes	Yes	Yes
•	•	•	•	•	•	•	•
Optional Software	Optional S.W./Yes	Optional Software	Optional Software	Optional Software	Optional Software	Optional Software	Optional Software
•	•	•	•	•	•	•	•
•	•	•	•	•	•	•	•
Yes	Yes	Yes			Yes	Yes	Yes
Up to 0.25" (6mm)	Up to 0.25" (6mm)	Up to 0.25" (6mm)	Up to 0.3" (7mm)	Up to 0.5" (12mm)	Up to 0.10 (2.5mm)	Up to 0.10 (2.5mm)	Up to 0.10 (2.5mm)
3	3	3	2	2	3	3	3
Optional Software	Optional Software	Optional Software	Optional Software	Optional Software	Optional Software	Optional Software	Optional Software
Yes	Yes	Yes	Yes	Yes	No	No	No
Up to 200 dpi (79 d/cm)	Up to 200 dpi (79 d/cm)	Up to 200 dpi (79 d/cm)	Continuous	Continuous	Up to 200 dpi (79 d/cm)	Up to 200 dpi (79 d/cm)	Up to 200 dpi (79 d/cm)
115 or 220 VAC	115 or 220 VAC	115 or 220 VAC	115 or 220 VAC	115 or 220 VAC	115 or 220 VAC	115 or 220 VAC	115 or 220 VAC
60-100 PSIG (4.1-6.9 Bars)	60-100 PSIG (4.1-6.9 Bars)	60-100 PSIG (4.1-6.9 Bars)	60-100 PSIG (4.1-6.9 Bars)	60-100 PSIG (4.1-6.9 Bars)	None	None	None
		Optional			Optional	Optional	