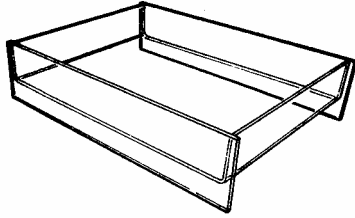

TABLE OF CONTENTS

BINS / TRAYS	2
EASELS / RISERS	4
LITERATURE	12
SIGN HOLDERS	16
SHOWCASES	18
FLOOR FIXTURES	19
SHELVING	22
APPAREL / JEWELERY	26
MIRRORS	30
COUNTERTOP	31
FOOD / BULK DISPENCERS	33
MISCELLANEOUS	35
DIMENSIONAL LETTERS	36
ORDERING INFORMATION	41
NOTES	



PAPER TRAYS

Made from 1/8" clear acrylic.

<u>Item</u>	<u>H x W x D</u>	<u>Price</u>	<u>Min. order</u>
PT11	9 x 11 3/8 x 2 3/8	9.48	6
PT14	14 1/8 X 11 3/8 X 2 3/8	15.57	6

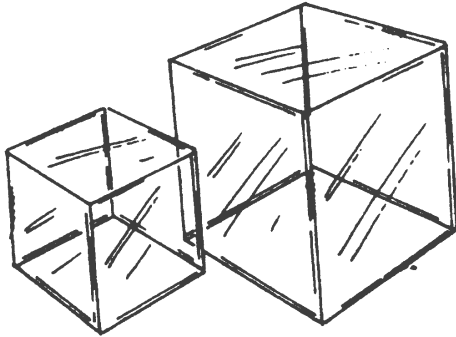

BINS

Made from 1/8" & 3/16" clear acrylic and have open bottom.

<u>Item</u>	<u>H x W x D</u>	<u>Price</u>	<u>Min. order</u>
BE04	4 x 4 x 4	4.47	4
BE05	5 x 5 x 5	6.99	4
BE06	6 x 6 x 6	10.15	4
BE07	7 x 7 x 7	18.03	4
BE10	10 x 10 x 10	25.73	4
BE12	12 x 12 x 12	36.75	4
BE15	15 x 15 x 15	55.94	4
BN16	16 x 16 x 16	55.94	2

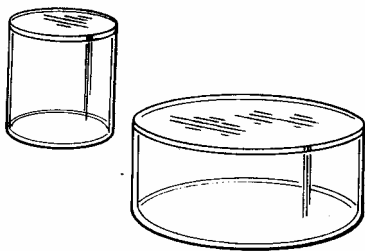

CYLINDER RISERS / BENS

Clear acrylic cylinders with one end closed. Can be used as riser or bins.

<u>Item</u>	<u>H x Diameter</u>	<u>Price</u>	<u>Min. order</u>
CB32	2 x 3		6
CB34	4 x 3		6
CB36	6 x 3		6
CB43	3 x 4		6
CB45	5 x 4		6

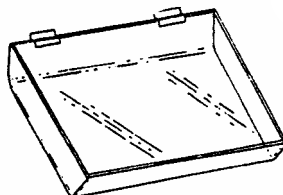

SLANTED TRAYS

Available for **Gridwall**, **Slatwall**, **Pegboard**, or **Wall mount**. Add a letter (**G**, **S**, **P**, or **W**) to the end of the item number. E.g. **ST12S**.

<u>Item</u>	<u>H x W x D</u>	<u>Price</u>	<u>Min. order</u>
ST08	2 x 8 x 8	9.24	6
ST12	2 x 12 x 8	13.97	6
ST16	2 x 16 x 8	17.43	6

DISPLAY TRAYS

Available for **G**ridwall, **S**latwall, **P**egboard, **W**all mount or **C**ounter. Add a letter (**G**, **S**, **P**, **W**, or **C**) to the end of the item number. E.g. ST12**S**.

<u>Item</u>	<u>H x W x D</u>	<u>Price</u>	<u>Min. order</u>
DT21	2 x 8 x 4	9.24	6
DT22	2 x 12 x 4	12.94	6
DT23	2 x 12 x 6	14.7	6
DT24	2 x 12 x 8	16.76	6
DT25	2 x 16 x 8	12.60	6
DT26	2 x 24 x 8	23.31	6
DT41	4 x 8 x 4	13.99	6
DT42	4 x 12 x 4	15.69	6
DT43	4 x 12 x 8	18.59	6
DT44	4 x 16 x 8	21.24	6
DT45	4 x 24 x 8	28.56	6

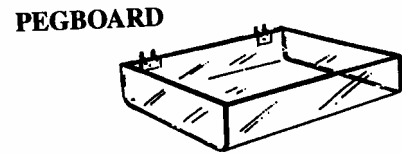
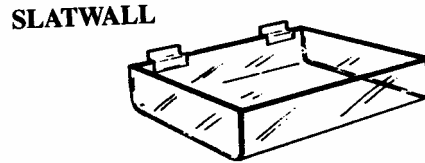
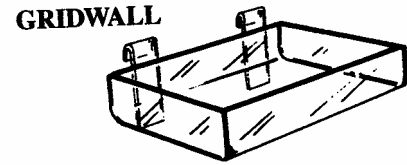

DEVIDED BINS

Each bin has four removable dividers.

Available for **G**ridwall, **S**latwall, **P**egboard, or **W**all mount . Add a letter (**G**, **S**, **P**, or **W**) to the end of the item number. E.g. ST12**S**.

<u>Item</u>	<u>H x W x D</u>	<u>Price</u>	<u>Min. order</u>
DB24	8 x 24 x 8	34.28	6
DB30	12 x 30 x 12	58.96	6

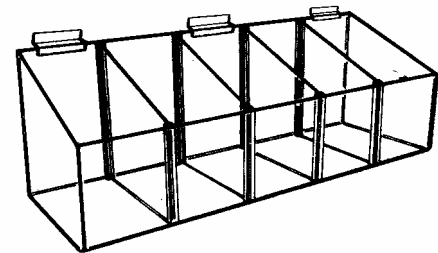

DOUBLE-WIDE TIERED BINS

These two and three level displays have compartments that are 4" high x 4" deep x 7 1/2" wide.

Available for **G**ridwall, **S**latwall, **P**egboard, or **W**all mount . Add a letter (**G**, **S**, **P**, or **W**) to the end of the item number. E.g. ST12**S**.

<u>Item</u>	<u>H x W x D</u>		<u>Price</u>	<u>Min. order</u>
DW02	8 5/8 x 15 1/2 x 9	Two tier	33.68	6
DW03	12 3/8 x 15 1/2 x 13	Three tier	43.32	6

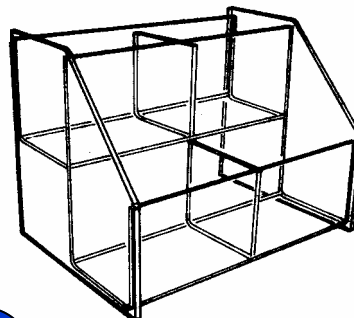
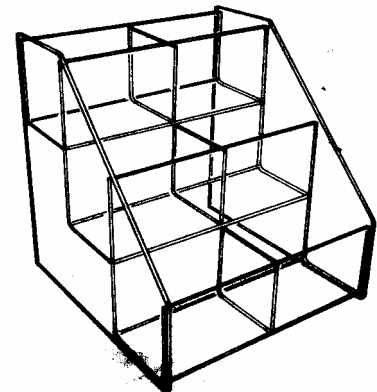

COUNTER TO EASELS

1" opening

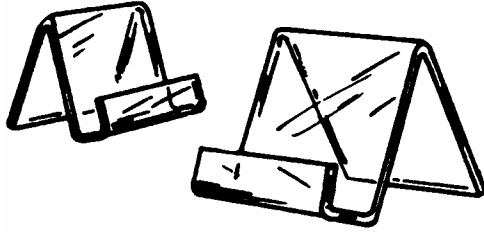

<u>Item</u>	<u>H x W</u>	<u>Price</u>	<u>Min. order</u>
CE01	4 x 3 1/2	2.92	6
CE02	6 x 5 1/2	3.98	6
CE03	8 x 7 1/2	5.42	6
CE04	11 x 9	8.12	6
CE05	13 1/2 x 9 1/2	10.83	6

WIDE OPENING EASELES

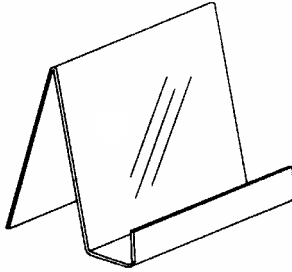

<u>Item</u>	<u>H x W</u>	<u>Opening</u>	<u>Price</u>	<u>Min. order</u>
WE69	3 1/2 x 3 1/2	3	2.94	6
WE61	5 1/2 x 3 1/2	3	3.41	6
WE63	6 x 5 1/2	3	3.63	6
WE65	8 x 7 1/2	3	6.01	6
WE73	4 x 3 1/2	3	2.75	6
WE74	4 x 3 1/2	2	2.75	6
WE75	6 x 5 1/2	3	4.47	6

DOUBLE EASELS

1 1/4" Openings

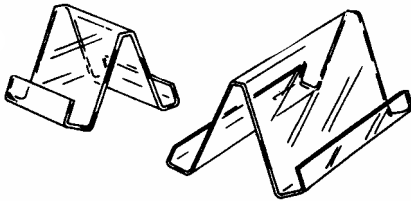

<u>Item</u>	<u>H x W</u>	<u>Price</u>	<u>Min. order</u>
DE09	14 x 9	12.18	6
DE23	14 x 23	28.16	6
DE11	9 1/2 x 11 1/2	8.58	6

BINDER EASELS

Standard 1" capacity ring binder

Available for **G**ridwall, **S**latwall, **P**egboard, **W**all mount or **C**ounter. Add a letter (**G**, **S**, **P**, **W**, or **C**) to the end of the item number. E.g. ST12**S**.

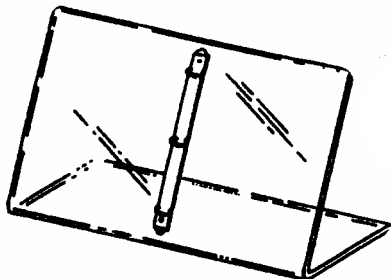

<u>Item</u>	<u>H x W</u>	<u>Price</u>	<u>Min. order</u>
NE06	13 3/4 x 18 1/2	31.61	4

LAI D BACK EASALES

Ideal for open or closed books & soft goods (ties, shirts, etc).

Item	H x W x D	Lip	Price	Min. order
LB12	4 1/2 x 12 x 9	1 1/2	8.38	6
LB18	6 x 18 x 12	2	15.75	6
LB24	6 x 24 x 12	2	20.98	6

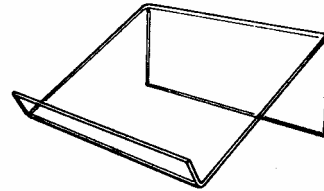

SLATWALL EASELS

1" Front lip, 50 Deg tilt

Available for **G**ridwall, **S**latwall, **P**egboard, or **W**all mount . Add a letter (**G**, **S**, **P**, or **W**) to the end of the item number. E.g. ST12**S**.

Item	H x W x D	Price	Min. order
EW03	7 1/2 x 3 3/4 x 1 1/4	4.52	6
EW05	8 x 5 3/4 x 2 3/4	5.46	6
EW07	7 1/2 x 7 3/4 x 1 1/4	6.38	6
EW11	8 x 11 3/4 x 2 3/4	8.58	6

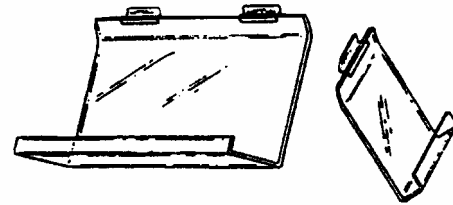

BINS

Made from 1/8" & 3/16" clear acrylic and have open bottom.

Item	H x W x D	Price	Min. order
BE04	4 x 4 x 4	4.47	4
BE05	5 x 5 x 5	6.69	4
BE06	6 x 6 x 6	10.15	4
BE07	7 x 7 x 7	18.03	4
BE10	10 x 10 x 10	25.73	4
BE12	12 x 12 x 12	36.75	4
BE15	15 x 15 x 15	55.94	4
BN16	16 x 16 x 16	55.94	2

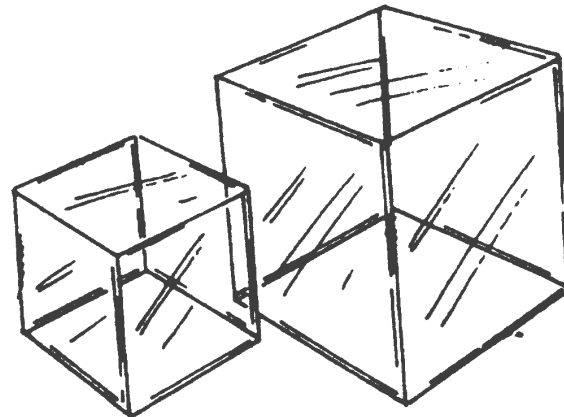

CYLINDER RISERS

Clear acrylic cylinders with closed bottom. Can be used as riser or buns.

Item	H x Diameter	Price	Min. order
CB32	2 x 3		6
CB34	4 x 3		6
CB36	6 x 3		6
CB43	3 x 4		6
CB45	5 x 4		6

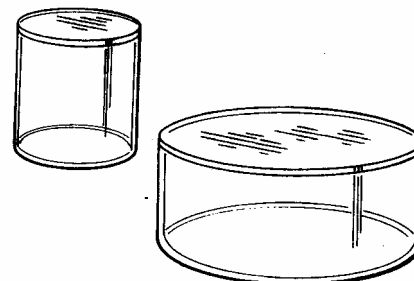

SQUARE RISERS

Made from clear acrylic.

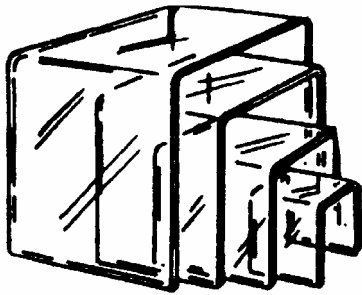

<u>Item</u>	<u>H x W x D</u>	<u>Thickness</u>	<u>Price</u>	<u>Min. order</u>
RS01	1 x 1 x 1	1/8	1.35	6
RS02	2 x 2 x 2	1/8	1.62	6
RS03	3 x 3 x 3	1/8	2.44	6
RS04	4 x 4 x 4	1/8	3.57	6
RS05	5 x 5 x 5	1/8	4.93	6
RS06	6 x 6 x 6	3/16	10.24	6
RS07	7 x 7 x 7	3/16	8.57	6
RS08	8 x 8 x 8	1/4	11.80	4
RS09	9 x 9 x 9	1/4	13.91	4
RS10	10 x 10 x 10	1/4	14.76	4
RS11	11 x 11 x 11	1/4	17.89	4
RS12	12 x 12 x 12	1/4	21.29	4
RS16	16 x 16 x 16	3/8	37.83	2

LONG RISERS

Made from clear acrylic.

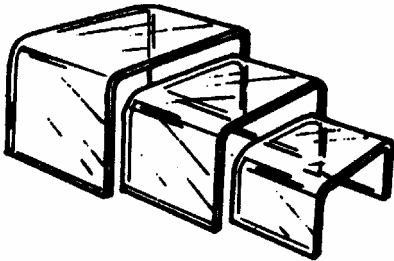

<u>Item</u>	<u>H x W x D</u>	<u>Thickness</u>	<u>Price</u>	<u>Min. order</u>
LR01	1 x 1 1/2 x 1	1/8	1.62	6
LR02	2 x 3 x 2	1/8	2.44	6
LR03	3 x 4 1/2 x 3	1/8	2.98	6
LR04	4 x 6 x 4	1/8	4.12	6
LR05	5 x 7 1/2 x 5	1/8	6.28	6
LR06	6 x 9 x 6	3/16	8.06	6
LR07	7 x 10 1/2 x 7	3/16	9.63	6
LR08	8 x 12 x 8	1/4	12.14	4
LR09	9 x 13 1/2 x 9	1/4	15.69	4
LR10	10 x 15 x 10	1/4	18.95	4
LR12	12 x 18 x 12	1/4	24.84	4

CORNER TURN RISERS

Made from clear acrylic.

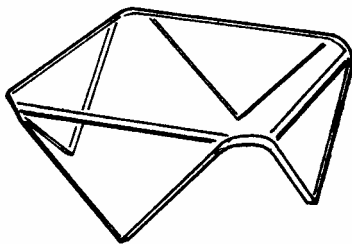

<u>Item</u>	<u>H x W x D</u>	<u>Thickness</u>	<u>Price</u>	<u>Min. order</u>
CT04	2 x 4 x 4	1/8	4.40	6
CT06	3 x 6 x 6	1/8	6.07	6
CT08	4 x 8 x 8	3/16	8.12	6
CT10	5 x 10 x 10	3/16	13.10	6
CT12	6 x 12 x 12	1/4	21.29	4

SHORT RISERS

Made from clear acrylic.

<u>Item</u>	<u>H x W x D</u>	<u>Thickness</u>	<u>Price</u>	<u>Min. order</u>
SR02	1 x 2 x 2	1/8	1.62	6
SR03	1 1/2 x 3 x 3	1/8	2.27	6
SR04	2 x 4 x 4	1/8	3.57	6
SR05	2 1/2 x 5 x 5	1/8	4.87	6
SR06	3 x 6 x 6	3/16	5.78	6
SR07	3 1/2 x 7 x 7	3/16	7.88	6
SR08	4 x 8 x 8	1/4	9.37	4
SR09	4 1/2 x 9 x 9	1/4	11.36	4
SR10	5 x 10 x 10	1/4	13.06	4
SR12	6 x 12 x 12	1/4	20.82	4

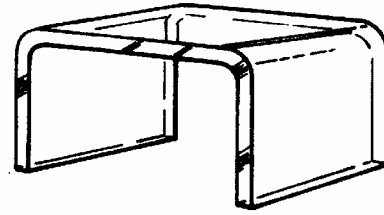

TALL RISERS

Made from clear acrylic.

<u>Item</u>	<u>H x W x D</u>	<u>Thickness</u>	<u>Price</u>	<u>Min. order</u>
TR01	1 1/2 x 1 3/8 x 1	1/8	1.35	6
TR02	3 x 2 x 2	1/8	2.18	6
TR03	4 1/2 x 3 x 3	1/8	2.56	6
TR04	6 x 4 x 4	1/8	4.26	6
TR05	7 1/2 x 5 x 5	3/16	5.59	6
TR06	9 x 6 x 6	3/16	6.93	6
TR07	10 1/2 x 7 x 7	1/4	9.65	4
TR08	12 x 8 x 8	1/4	13.49	4
TR09	13 1/2 x 9 x 9	1/4	17.75	4
TR10	15 x 10 x 10	1/4	19.66	4

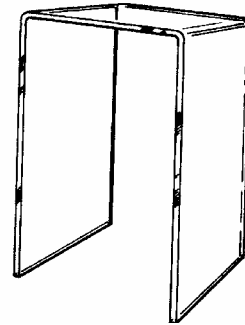

NARROW RISERS

Made from clear acrylic.

<u>Item</u>	<u>H x W x D</u>	<u>Thickness</u>	<u>Price</u>	<u>Min. order</u>
NR02	2 x 2 x 1	1/8	1.69	6
NR03	3 x 3 x 1 1/2	1/8	2.27	6
NR04	4 x 4 x 2	1/8	2.92	6
NR05	5 x 5 x 2 1/2	1/8	4.55	6
NR06	6 x 6 x 3	3/16	6.03	6
NR07	7 x 7 x 3 1/2	3/16	8.23	6
NR08	8 x 8 x 4	1/4	9.50	4
NR09	9 x 9 x 4 1/2	1/4	11.97	4
NR10	10 x 10 x 5	1/4	10.79	4
NR12	12 x 12 x 6	1/4	15.14	4

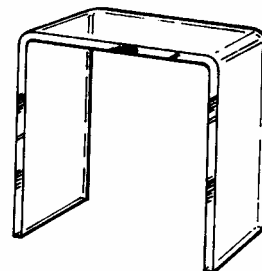

SIGN HOLDER RISERS

Made from clear acrylic.

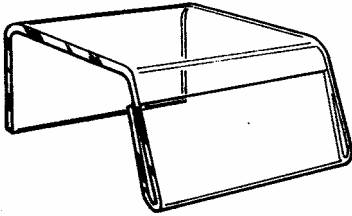

<u>Item</u>	<u>H x W x D</u>	<u>Sign Space</u>	<u>Price</u>	<u>Min. order</u>
HR01	1 1/4 x 1 1/4 x 1 3/4	1 x 1 1/4	2.84	6
HR02	1 1/4 x 1 3/4 x 2 1/4	1 x 1 3/4	2.92	6
HR03	1 1/4 x 2 1/2 x 2 3/4	1 x 2 1/2	3.22	6
HR04	1 1/4 x 5 x 2 3/4	1 x 5	3.57	6
HR05	2 1/4 x 4 1/2 x 5 1/4	2 x 4 1/4	4.87	6
HR06	2 3/4 x 5 1/2 x 6 3/4	2 1/2 x 5 1/2	6.63	6
HR07	3 1/4 x 6 1/2 x 8 1/4	3 x 6 1/2	7.59	6

BEVELED GLASS GREEN RISERS

Made from 1/4" green edge acrylic.

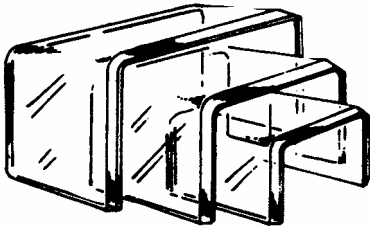

<u>Item</u>	<u>H x W x D</u>	<u>Price</u>	<u>Min. order</u>
GR04	4 x 4 x 4	4.54	6
GR05	5 x 5 x 5	6.65	6
GR06	6 x 6 x 6	9.59	6
GR07	7 x 7 x 7	13.04	6
GR08	8 x 8 x 8	15.70	6
GR09	9 x 9 x 9	19.83	6
GR10	10 x 10 x 10	24.55	6

MIRROR RISERS

Made from 1/8" mirror acrylic.

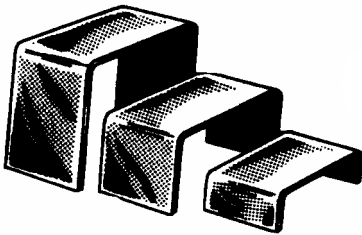

<u>Item</u>	<u>H x W</u>	<u>Price</u>	<u>Min. order</u>
MR02	2 x 2 x 2	2.67	6
MR03	3 x 3 x 3	3.51	6
MR04	4 x 4 x 4	5.52	6
MR05	5 x 5 x 5	7.24	6
MR06	6 x 6 x 6	8.88	6

BLACK BASE RISERS

Made from 1/8" Black Acrylic. Five sided.

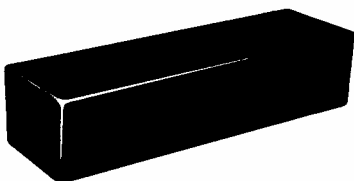

<u>Item</u>	<u>H x W x D</u>	<u>Price</u>	<u>Min. order</u>
BB12	2 x 12 x 2	13.42	6
BB14	3 x 14 x 4	16.05	6
BB16	4 x 16 x 6	18.98	6

SQUARE BARBELL RISERS

Made from acrylic rods. Shipped unassembled.

<u>Item</u>	<u>H x Square</u>	<u>Thickness</u>	<u>Price</u>	<u>Min. order</u>
SB23	2 1/4 x 3	3/16	3.34	6
SB43	4 3/8 x 3	3/16	3.68	6
SB63	6 3/8 x 3	3/16	4.39	6
SB83	8 3/8 x 3	3/16	5.44	6
SB13	10 1/2 x 3	1/4	6.59	6
SB44	4 1/2 x 4	1/4	4.22	6
SB64	6 1/2 x 4	1/4	5.27	6
SB84	8 1/2 x 4	1/4	6.32	6
SB14	10 1/2 x 4	1/4	7.37	6
SB24	12 1/2 x 4	1/4	7.39	6
SB66	6 1/2 x 6	1/4	7.49	6
SB86	8 1/2 x 6	1/4	8.52	6
SB16	10 1/2 x 6	1/4	9.57	6
SB26	12 1/2 x 6	1/4	9.57	6

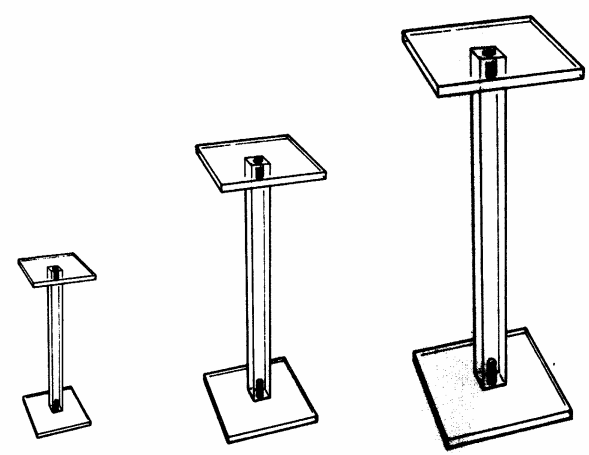

ROUND BARBELL RISERS

Made from acrylic rods. Shipped unassembled.

<u>Item</u>	<u>H x Diameter</u>	<u>Thickness</u>	<u>Price</u>	<u>Min. order</u>
RB43	4 1/4 x 3	3/16	3.68	6
RB44	4 1/4 x 4 1/2	3/16	5.25	6
RB63	6 3/8 x 3	3/16	4.39	6
RB64	6 3/8 x 4 1/2	3/16	5.96	6
RB86	8 x 6	1/4	8.52	6
RB87	8 x 7 1/2	1/4	11.51	6
RB96	9 1/2 x 6	1/4	10.53	6
RB97	9 1/2 x 7 1/2	1/4	12.01	6

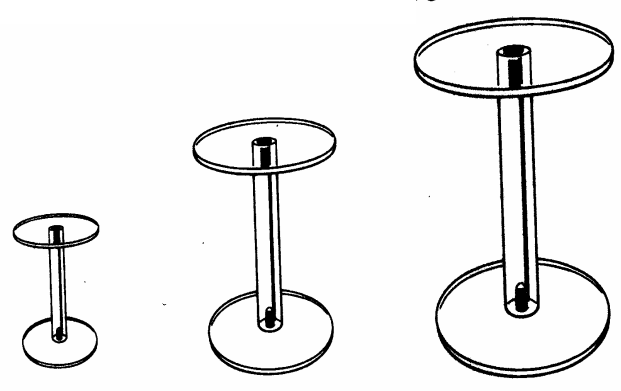

THICK BEVELED RISERS

Made from 3/8" acrylic.

<u>Item</u>	<u>H x W x D</u>	<u>Price</u>	<u>Min. order</u>
BR06	6 x 6 x 6	12.51	4
BR08	8 x 8 x 8	21.86	4
BR10	10 x 10 x 10	34.53	4
BR12	12 x 12 x 12	49.76	4
BR14	14 x 14 x 14	67.85	4
BR16	16 x 16 x 16	88.51	4

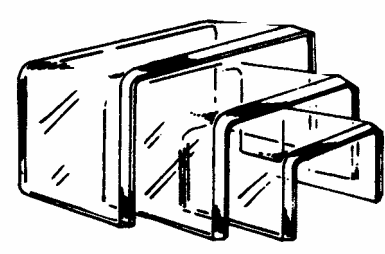

COUNTERTOP TABLES

Tables are constructed with round acrylic rod and are shipped unassembled.

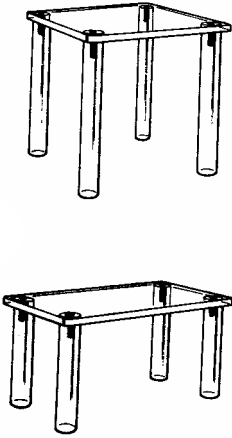

ITEM	<u>H x W x D</u>	<u>Price</u>	<u>Min. order</u>
TC02	6 x 6 x 6	7.55	4
TC03	8 x 8 x 8	8.99	4
TC04	8 x 12 x 12	14.00	4
TC05	4 x 8 x 7	5.49	4
TC06	8 x 12 x 8	8.09	4
TC07	8 x 16 x 10	12.21	4

ROUND COUNTER TOP TABLES

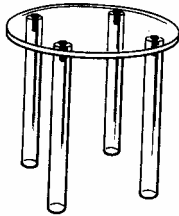

Item	<u>H x Diameter</u>	<u>Price</u>	<u>Min. order</u>
TC11	8 x 6	4.31	4
TC12	8 x 8	8.51	4
TC13	8 x 12	11.20	4
TC14	8 x 16	17.92	4
TC15	8 x 20	27.58	4

TWO STEP RISER

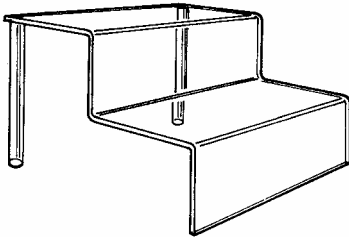

Item	<u>H x W x D</u>	<u>Stair Depth</u>	<u>Price</u>	<u>Min. order</u>
TS08	4 1/4 x 8 x 8 1/2	4	11.02	4
TS12	6 1/4 x 12 x 10 1/4	5	18.03	4
TS18	6 1/4 x 18 x 10 1/2	5	27.17	4

FLANGED STAIR

Good for displaying boxed or packaged items. Also works well for cards.

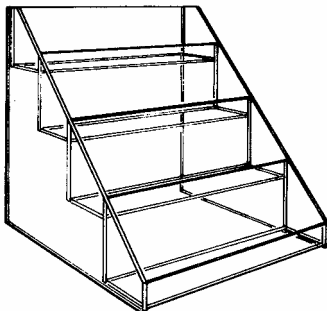

Item	<u>H x W x D</u>	<u>Stair Depth</u>	<u>Price</u>	<u>Min. order</u>
FS08	8 1/4 x 10 1/4 x 8 1/8	1 3/4	29.93	4
FS09	9 x 12 1/2 x 9 1/4	2	34.59	4
FS10	10 x 10 3/16 x 11	2 1/2	32.04	4
FS13	13 x 12 1/4 x 13	3	41.86	4
FS14	13 x 18 x 13	3	49.48	4
FS17	17 1/2 x 19 x 17 1/2	3 7/8	48.51	4

REVERSABLE STAIR

These stairs are designed to be used two ways.

<u>Item</u>	<u>H x W x D</u>	<u>Stair Depth</u>	<u>Price</u>	<u>Min. order</u>
RS08	8 x 12 1/4 x 6 1/2	2 or 2 1/2	32.65	4
RS09	9 x 14 x 14 1/4 x 6 1/2	2 or 3	34.39	4
RS11	11 x 18 1/2 x 7 3/4	2 1/2 or 3 1/2	42.40	4

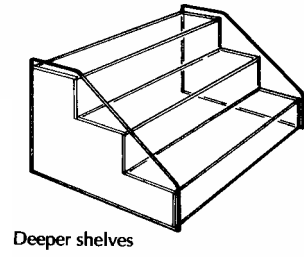
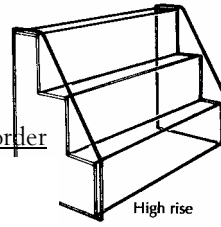

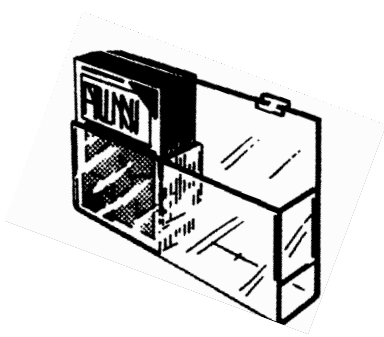

MAGAZINE RACK

Two compartments with 9" front lip for stability

Available for **Gridwall**, **Slatwall**, **Pegboard**, or **Wall mount** . Add a letter (**G**, **S**, **P**, or **W**) to the end of the item number. E.g. ST12**S**.

<u>Item</u>	<u>H x W x D</u>	<u>Price</u>	<u>Min. order</u>
FM78	11" x 17 1/2 x 3	37.69	4

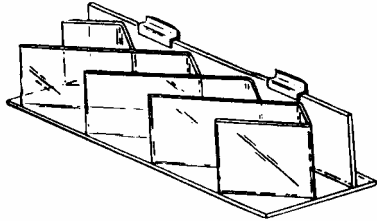

BOOK DISPLAYER

Available for **Gridwall**, **Slatwall**, **Pegboard**, or **Wall mount** . Add a letter (**G**, **S**, **P**, or **W**) to the end of the item number. E.g. ST12**S**.

<u>Item</u>	<u>H x W x D</u>		<u>Price</u>	<u>Min. order</u>
BD4R	6 x 23 3/4 x 9 3/4	Right Slant	56.70	4
BD4L	6 x 23 3/4 x 9 3/4	Left Slant	56.70	4

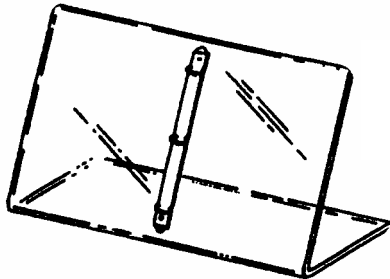

BINDER EASELS

Standard 1" capacity ring binder.

Available for **Gridwall**, **Slatwall**, **Pegboard**, **Wall mount** or **Counter**. Add a letter (**G**, **S**, **P**, **W**, or **C**) to the end of the item number. E.g. ST12**S**

<u>Item</u>	<u>H x W</u>	<u>Price</u>	<u>Min. order</u>
NE06	13 3/4 x 18 1/2	31.61	4

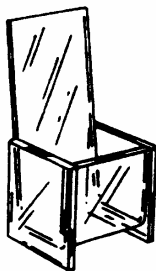

COUNTERTOP

1 1/2" Deep pockets

<u>Item</u>	<u>For</u>	<u>Price</u>	<u>Min. order</u>
CC81	4"W x 9"H brochures	4.89	12
CC85	8 1/2"W x 11"H brochures	9.78	12
			1

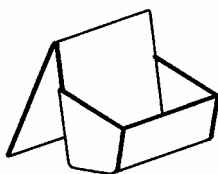

BUSINESS CARD

Available for **Gridwall**, **Slatwall**, **Pegboard**, **Wall mount** or **Counter**. Add a letter (**G**, **S**, **P**, **W**, or **C**) to the end of the item number. E.g. ST12**S**

<u>Item</u>	<u>H x W x D</u>	<u>Price</u>	<u>Min. order</u>
BC80	2 x 3 1/2 x 3/4	3.45	12

MULTI BUSINESS CARD

Available for Gridwall, Slatwall, Pegboard, Wall mount or Counter.
Add a letter (**G**, **S**, **P**, **W**, or **C**) to the end of the item number. E.g.

<u>Item</u>	<u>H x W x D</u>	<u>Pockets</u>	<u>Price</u>	<u>Min. order</u>
BC01	9 1/2 x 6 x 6	3	10.00	2
BC02	9 1/2 x 10 1/4 x 6	6	19.42	2
BC03	9 1/2 x 16 x 6	9	28.81	2
BC04	9 1/2 x 21 x 6	12	38.20	2

<u>Item</u>	<u>H x W x D</u>	<u>Pockets</u>	<u>Price</u>	<u>Min. order</u>
BC11	10 x 6 x 1 1/8	3	10.62	2
BC12	10 x 10 x 1 1/8	6	15.69	2
BC13	13 x 10 x 1 1/8	9	22.92	2
BC14	19 x 10 x 1 1/8	12	30.07	2

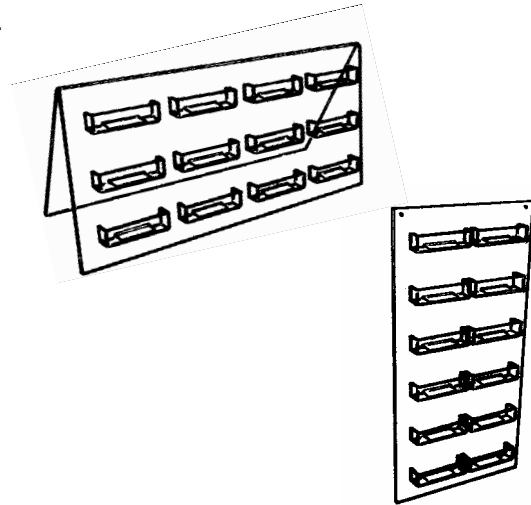

BALLOT BOX

<u>Item</u>	<u>H x W x D</u>		<u>Price</u>	<u>Min. order</u>
AB09	8 x 8 x 8	With Lock	47.69	4
AB02	8 x 8 x 8	Without Lock	40.34	4
AB03	10 x 10 x 10	With Lock	67.41	4
AB04	10 x 10 x 10	Without Lock	61.11	4

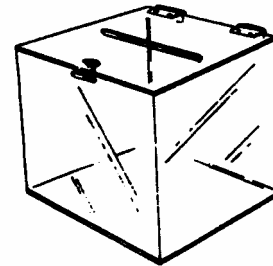

BALLOT BOX

With lock, and removable sign holder

<u>Item</u>	<u>H x W x D</u>	<u>Price</u>	<u>Min. order</u>	
AB16	6 x 4 x 4	18.31	4	Clear
AB17	6 x 4 x 4	21.82	4	White
AB18	11 x 7 x 7	34.39	4	Clear
AB19	11 x 7 x 7	43.61	4	White

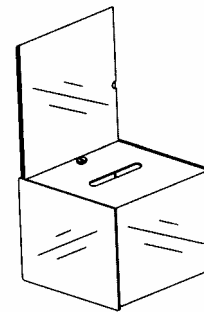

BALLOT BOX

With 4"W x 1 3/8"D pocket and 4"W x 6"H sign holder. Box secures w/ zip tie.

<u>Item</u>	<u>H x W x D</u>	<u>Price</u>	<u>Min. order</u>
AB24	6 x 4 x 4	20.41	4

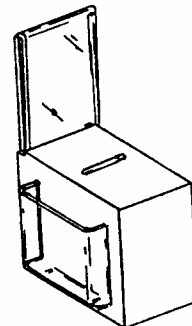

BROCHURE HOLDERS

2" Deep pockets

Available for **G**ridwall, **S**latwall, **P**egboard, or **W**all mount . Add a letter (**G**, **S**, **P**, or **W**) to the end of the item number. E.g. ST12S.

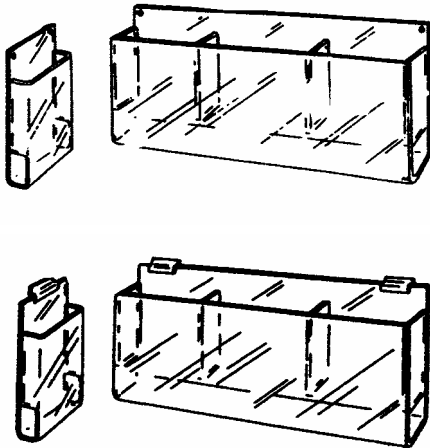

<u>Item</u>		<u>For</u>	<u>Price</u>	<u>Min. order</u>
BH41	Single		5.97	12
BH42	Double	4"W x 9"H brochures	10.32	6
BH43	Triple		15.51	4
BH81	Single		12.51	12
BH82	Double	8 1/2"W x 11"H brochures	20.31	6
BH83	Triple		31.27	4

TIERED BROCHURE HOLDERS

2" Deep pockets

Available for **G**ridwall, **S**latwall, **P**egboard, **W**all mount or **C**ounter. Add a letter (**G**, **S**, **P**, **W**, or **C**) to the end of the item number. E.g. ST12S

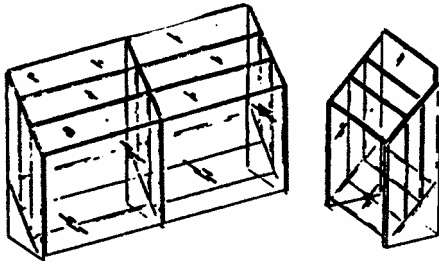

<u>Item</u>		<u>For</u>	<u>Price</u>	<u>Min. order</u>
TB43	Three Pocket	4"W x 9"H brochures	13.65	4
TB46	Six Pocket		23.56	4
TB83	Three Pocket	8 1/2"W x 11"H brochures	25.83	4
TB86	Six Pocket		36.86	4

SIGNHOLDERS WITH POCKET

Sign holder has pocket that hold 4"W x 9"H brochures.

Available for **G**ridwall, **S**latwall, **P**egboard, **W**all mount or **C**ounter. Add a letter (**G**, **S**, **P**, **W**, or **C**) to the end of the item number. E.g. ST12S

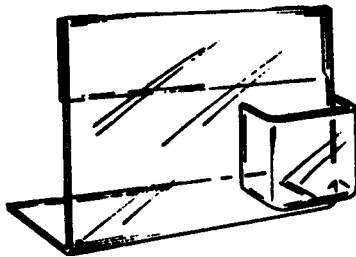

<u>Item</u>	<u>H x W</u>	<u>Price</u>	<u>Min. order</u>
SP11	11 x 13 1/2	17.33	4
SP16	16 3/4 x 21	32.49	4

SIGN HOLDER WITH POCKET

Sign holder has pocket that holds business cards .

Available for **G**ridwall, **S**latwall, **P**egboard, **W**all mount or **C**ounter. Add a letter (**G**, **S**, **P**, **W**, or **C**) to the end of the item number. E.g. ST12S

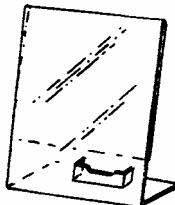

<u>Item</u>	<u>H x W</u>	<u>Price</u>	<u>Min. order</u>
SP08	11 x 8 1/2	10.92	4

SLOT BLOCK CARD/SIGN HOLDERS

Clear polished blocks of acrylic for small cards and also makes excellent displays for earrings and pin cards.

<u>Item</u>	<u>H x W x D</u>	<u>Price</u>	<u>Min. order</u>
SC01	3/8 x 1 1/4 x 1	.75	12
SC02	3/8 x 2 x 1	1.51	12
SC03	3/8 x 3 x 1 1/2	2.51	12
SC05	3/8 x 5 x 1 1/2	3.77	12

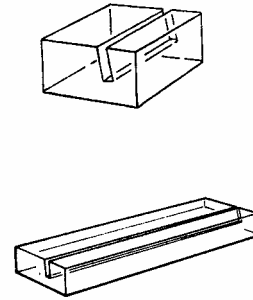

OUTDOOR LITITURE BOXES

Made from thick 1/4" acrylic for added durability

<u>Item</u>	<u>H x W x D</u>	<u>Price</u>	<u>Min. order</u>
UV21	13 x 10 x 4 Clear	72.45	2
UV31	13 x 10 x 4 Smoke	81.75	

ADD ON POCKETS

Add a business card pocket or tri-fold brochure pocket to any of our acrylic products. Ideal for sign frames, brochure holders, or even ballot boxes. The add-on pocket will be affixed to the lower right hand corner of acrylic product unless otherwise specified.

<u>Item</u>	<u>H x W x D</u>	<u>Price</u>
AP01	1 x 4 x 7/8	2.80
AP04	4 1/8 x 4 x 1	3.50

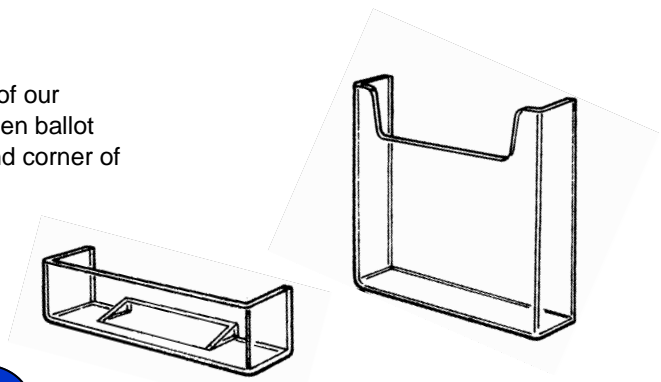

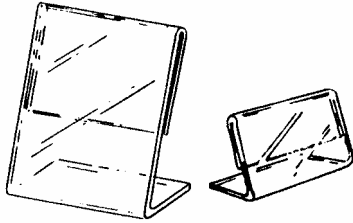
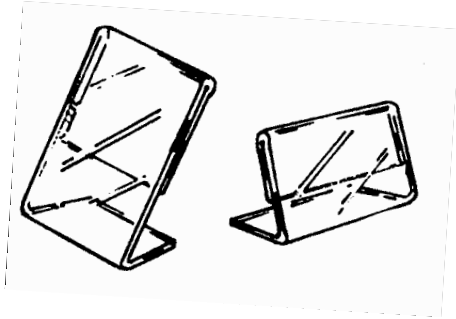

SLANT BACK

Made from 1/8" acrylic.

<u>Item</u>	<u>H x W</u>	<u>Price</u>	<u>Min. order</u>
BC01	5 1/2 x 3 1/2	1.79	12
BC02	3 1/2 x 5 1/2	1.90	12
BC03	2 1/2 x 3 1/2	1.23	12
BC04	2 x 3 1/2	1.23	12
BC05	7 x 5	2.82	12
BC06	5 x 7	2.82	12
BC07	5 3/4 x 7	3.03	12
BC08	4 x 5 3/8	2.06	12
BC09	7 x 5 1/2	2.89	12
BC10	5 1/2 x 7	2.65	12
BC11	11 x 7	5.26	12
BC12	11 x 7	5.26	12
BC13	11 x 8 1/2	6.09	12
BC14	8 1/2 x 11	6.09	12
BC15	14 x 11	11.16	12

BOTTOM LOAD SIGN HOLDERS

Made from 1/8" acrylic.

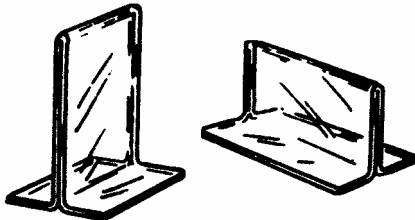

<u>Item</u>	<u>H x W</u>	<u>Price</u>	<u>Min. order</u>
BF01	5 1/2 x 3 1/2	3.22	12
BF02	3 1/2 x 5 1/2	3.33	12
BF03	2 1/2 x 3 1/2	1.71	12
BF04	2 x 3 1/2	1.71	12
BF05	7 x 5	3.99	12
BF06	5 x 7	4.60	12
BF07	5 3/4 x 7	4.81	12
BF08	4 x 5 3/8	3.05	12
BF09	7 x 5 1/2	4.33	12
BF10	5 1/2 x 7	4.60	12
BF11	11 x 7	6.82	12
BF12	7 x 11	6.82	12
BF13	11 x 8 1/2	7.68	12
BF14	8 1/2 x 11	7.68	12
BF15	14 x 11	11.56	12

DOUBLE PANEL FRAMES

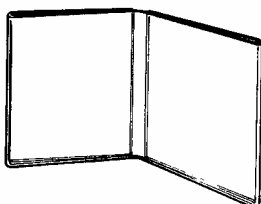

<u>Item</u>	<u>H x W</u>	<u>Price</u>	<u>Min. order</u>
DP05	5 x 3 1/2	4.55	12
DP06	6 x 4	4.91	12
DP07	7 x 5	6.24	12
DP11	11 x 8 1/2	11.40	12

TENT STYLE SIGN HOLDERS

<u>Item</u>	<u>H x W x D</u>	<u>Price</u>	<u>Min. order</u>
TH03	3 1/2 x 3 1/2 x 3	3.51	12
TH04	5 1/2 x 3 1/2 x 3	4.79	12
TH05	7 x 5 x 4	5.14	12
TH06	5 x 7 x 4 1/2	5.74	12
TH07	11 x 8 1/2 x 6	11.37	12
TH08	8 x 10 x 6	9.91	12

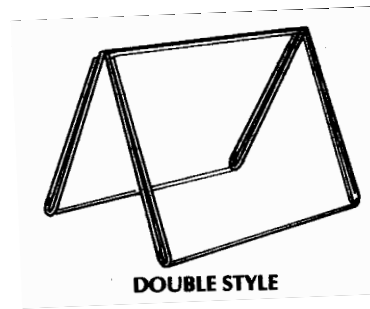

SIX SIDED SIGN HOLDERS

<u>Item</u>	<u>H x W</u>	<u>Price</u>	<u>Min. order</u>
SS06	6 x 4	5.96	12
SS07	7 x 5	7.58	12

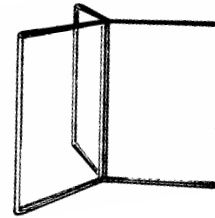

SIGN HOLDERS

Available for Gridwall, Slatwall, Pegboard, or Wall mount . Add a letter (G, S, P, or W) to the end of the item number. E.g. ST12S.

<u>Item</u>	<u>H x W</u>	<u>Price</u>	<u>Min. order</u>
SG12	3 x 3		12
SG13	2 7/8 x 2 7/8		12
SG14	5 1/2 x 3 1/2		12
SG15	3 1/2 x 5 1/2		12
SG16	7 x 5 1/2		12
SG17	5 1/2 x 7		12
SG18	2 x 3 1/2		12
SG19	11 x 7		12
SG20	7 x 11		12
	11 x 8 1/2		12

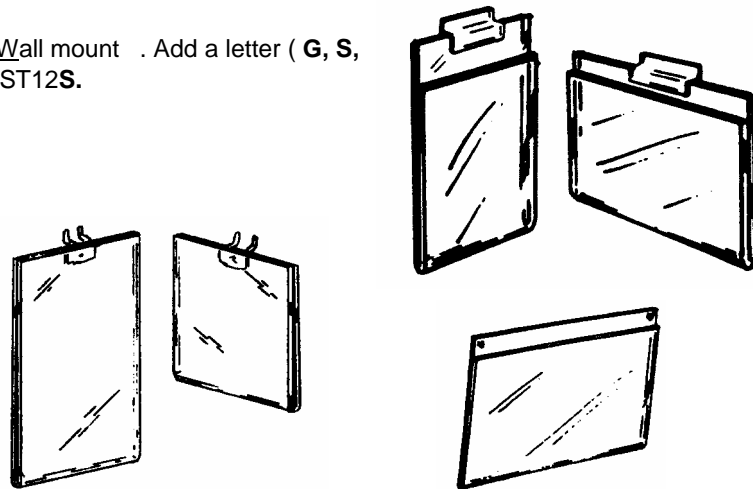

POSTER HOLDERS

Top of this acrylic frame is folded over to mount on a bracket, which is secured to the wall with screws.

<u>Item</u>	<u>H x W</u>	<u>Price</u>	<u>Min. order</u>
PH14	22 x 14	29.73	4
PH16	24 x 16	29.73	4
PH18	24 x 18	36.93	4
PH22	28 x 22	50.48	4
PH28	22 x 28	52.41	4
PH24	36 x 24	54.06	4
PH30	40 x 30	73.61	4
PH36	48 x 36	91.38	4

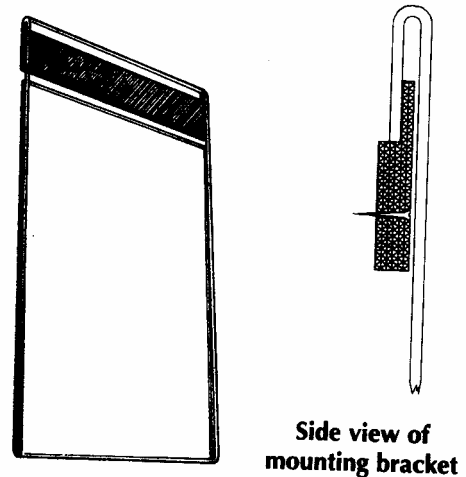

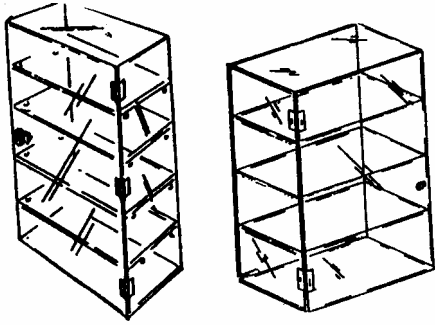

LOCKING SHOWCASE

Available for **G**ridwall, **S**latwall, **P**egboard, **W**all mount or **C**ounter. Add a letter (**G**, **S**, **P**, **W**, or **C**) to the end of the item number. E.g. ST12**S**

<u>Item</u>	<u>H x W x D</u>		<u>Price</u>	<u>Min. order</u>
SW75	21 x 7 1/2 x 13	3 Flat Shelves	145.31	2
SW77	15 x 10 x 5	4 Flat Shelves	116.16	2



NECKLACE SHOWCASE

Has removable bar for displaying chains and necklaces. Back panel slides out

<u>Item</u>	<u>H x W x D</u>	<u>Price</u>	<u>Min. order</u>
SW69	15 x 10 x 5	82.39	2

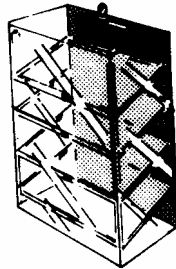

ANGELED SHELF SHOWCASE

Has 4 angled shelves for displaying boxed jewelry. Back panel slides out.

<u>Item</u>	<u>H x W x D</u>	<u>Price</u>	<u>Min. order</u>
SW70	15 x 10 x 5	105.66	2

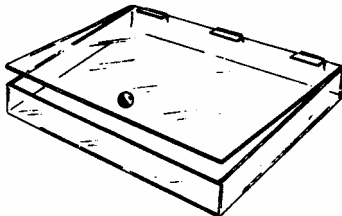

LOCKING COUNTERTOP

<u>Item</u>	<u>H x W x D</u>	<u>Price</u>	<u>Min. order</u>
SW63	6 x 24 x 18	102.19	2
SW64	3 x 24 x 18	85.06	2

BINS

Made from 1/8" & 3/16" clear acrylic and have open bottom.

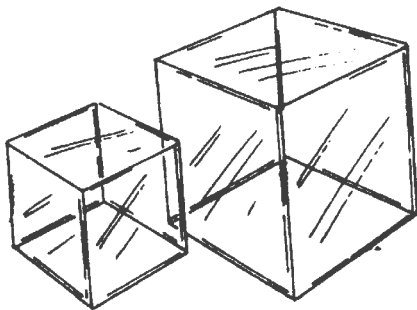

<u>Item</u>	<u>H x W x D</u>	<u>Price</u>	<u>Min. order</u>
BE04	4 x 4 x 4	4.47	4
BE05	5 x 5 x 5	6.99	4
BE06	6 x 6 x 6	10.15	4
BE07	7 x 7 x 7	18.03	4
BE10	10 x 10 x 10	25.73	4
BE12	12 x 12 x 12	36.75	4
BE15	15 x 15 x 15	55.94	4
BN16	16 x 16 x 16	55.94	2

THREE SHELF FLOOR TOWER

The three shelves of this display tower are made of heavy-duty 3/8" thick acrylic. The shelves are supported by the "V" supports, which also provides divided areas for the shelves. The 6 1/2" high base is made of gray, lightweight, PVC. Shipped unassembled.

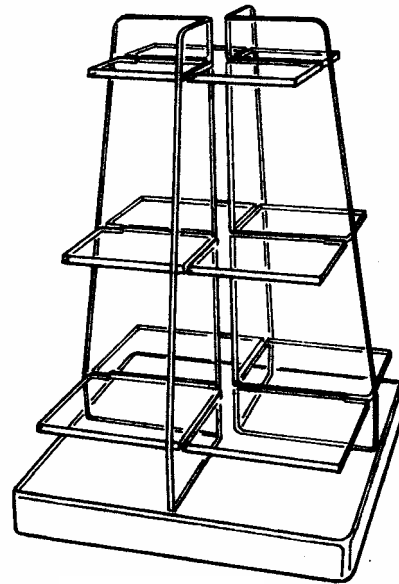

<u>Item</u>	<u>H x W x D</u>	<u>Price</u>	<u>Min. order</u>
FD10	54 X 41 X 37	538.81	1

V-SHELF FLOOR DISPLAY

The three V-shaped shelves in this display are 7 1/2" deep with 18" space between them. The 6 1/2" high base is made of gray, light weight, PVC. Shipped unassembled.

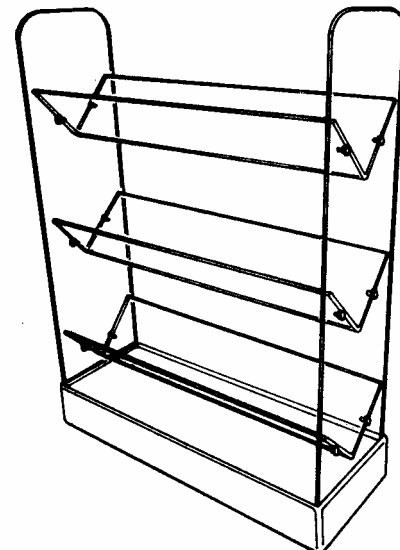

<u>Item</u>	<u>H x W x D</u>	<u>Price</u>	<u>Min. order</u>
FD20	61 x 47 x 17	492.47	1

Screw clips are used to construct shelves on this page.



FOUR SHELF DISPLAY

Clear acrylic shelves with gray, light weight, PVC base. Open front and back, this rack has four flat shelves (13" x 16" and 13 1/4" apart) for easy access. Shipped unassembled.



<u>Item</u>	<u>H x W x D</u>	<u>Price</u>	<u>Min. order</u>
FD30	54 x 17 1/4 x 16	285.55	1

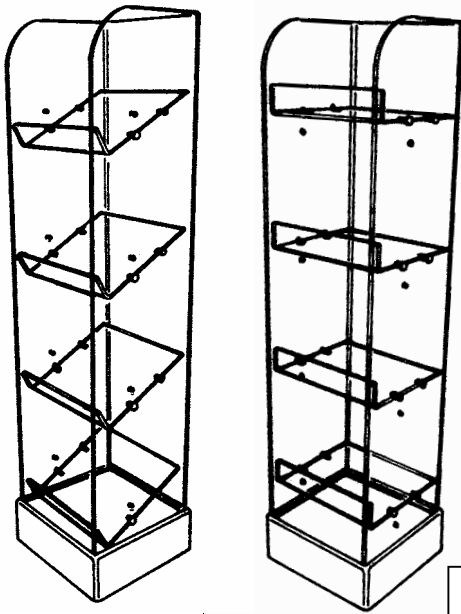

ADJUSTABLE SHELF TOWER

This shelf tower allows for different placement of shelves (straight or angled). Made from 1/4" acrylic. The 6 1/2" high base is made of gray, lightweight, PVC. Shipped unassembled.

<u>Item</u>	<u>H x W x D</u>	<u>Price</u>	<u>Min. order</u>
FD40	54 x 14 x 37	407.68	1

Screw clips are used to construct shelves on this page.

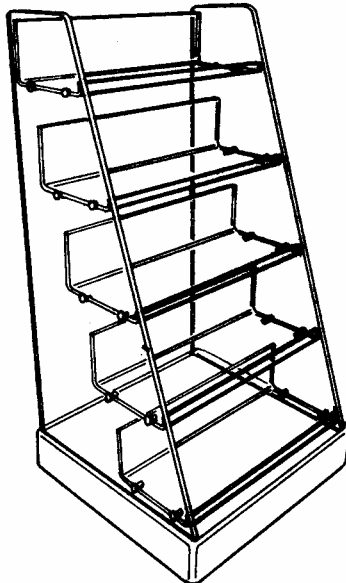

STAIR STEP FLOOR DISPLAY

Staggered shelves are 12" deep, 7" high back, and have a 1" lip. The 6 1/2" high base is made of gray, light weight, PVC. Shipped unassembled.

<u>Item</u>	<u>H x W x D</u>	<u>Price</u>	<u>Min. order</u>
FD50	63 x 32 x 31	711.80	1

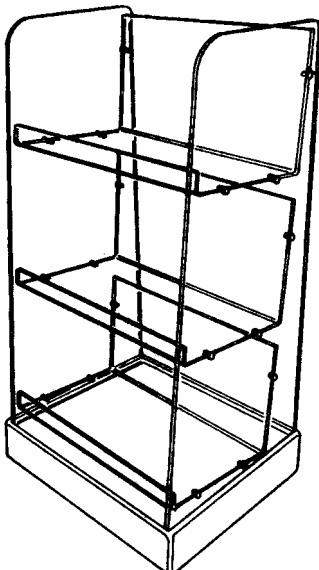

WIDE AND DEEP SHELVES

This shelf unit features extra wide and deep shelves for larger items. Shelves are made of 1/4" thick clear acrylic (18" deep x 30" wide). The 6 1/2" high base is made of gray, lightweight, PVC. Shipped unassembled.

<u>Item</u>	<u>H x W x D</u>	<u>Price</u>	<u>Min. order</u>
FD60	62 x 32 x 27 1/4	578.14	1

DOUBLE V SHELF

By repositioning the screw clips in this display, the shelves can either be flat, or tilted back. Clearance between shelves is either 9 1/4" (tilted) or 10 1/4" (flat). Shelves are made front 1/4" clear acrylic. The 6 1/2" high base is made of gray, lightweight, PVC. Shipped unassembled.

<u>Item</u>	<u>H x W x D</u>	<u>Price</u>	<u>Min. order</u>
FD70	54 x 41 x 37	885.86	1

Shelves are 9 3/4" deep with 1 1/4" lip

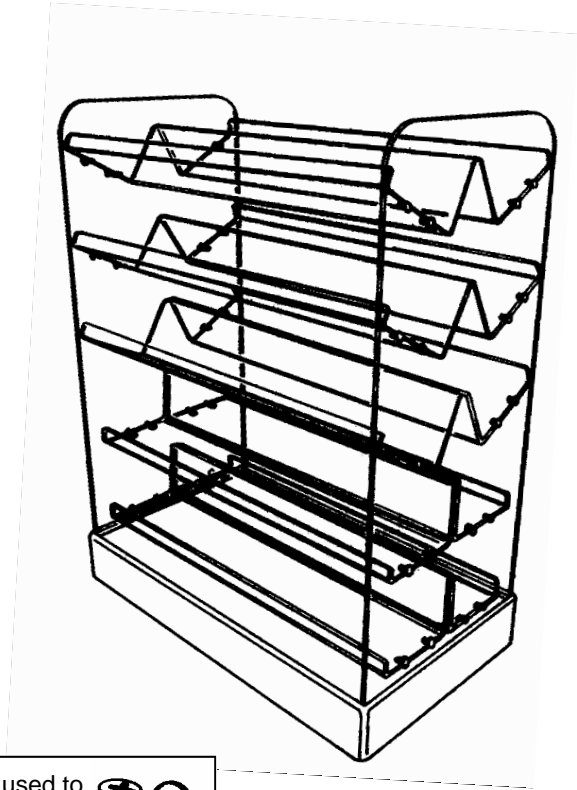

Screw clips are used to construct shelves on this page.





BOOK / SOFTWARE HOLDERS

Available for **Gridwall**, **Slatwall**, **Pegboard**, or **Wall mount** . Add a letter (**G**, **S**, **P**, or **W**) to the end of the item number. E.g. ST12**S**.

<u>Item</u>	<u>H x W x D</u>	<u>Price</u>	<u>Min. order</u>
KS70	4 1/4 wide w/ 4 1/8" front lip	4.63	12
KS74	6 1/2 wide w/ 4 5/8" front lip	5.63	12

J-RACKS WITH 20 deg TILT

These J-racks have a 2 1/2" front lip and are 1 1/2" deep.

Available for **Gridwall**, **Slatwall**, **Pegboard**, or **Wall mount** . Add a letter (**G**, **S**, **P**, or **W**) to the end of the item number. E.g. ST12**S**.

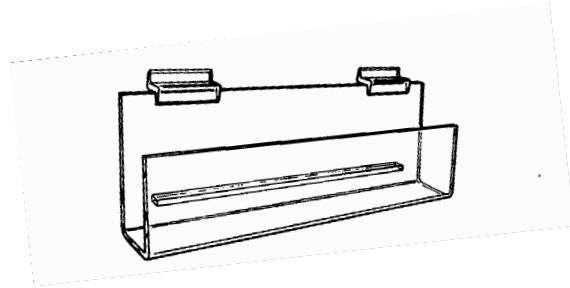

<u>Item</u>	<u>W</u>	<u>Price</u>	<u>Min. order</u>
KS08	8	6.90	12
KS12	11 3/4	7.30	12
KS24	23 3/4	9.97	12
KS36	35 3/4	14.19	12
KS48	47 3/4	20.98	12

LARGE J-RACKS WITH 20 deg

These J-racks have a 1 1/4" front lip and are 5 1/4" deep.

Available for **Gridwall**, **Slatwall**, **Pegboard**, or **Wall mount** . Add a letter (**G**, **S**, **P**, or **W**) to the end of the item number. E.g. ST12**S**.

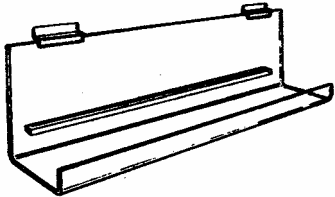

<u>Item</u>	<u>W</u>	<u>Price</u>	<u>Min. order</u>
JR08	8	8.03	6
JR12	11 3/4	11.25	6
JR24	23 3/4	19.99	6
JR36	35 3/4	29.99	6
JR48	47 3/4	37.49	6

DELUX STRAIGHT SHELVES

Made from 1/4" clear acrylic.

Available for **Gridwall**, **Slatwall**, **Pegboard**, or **Wall mount** . Add a letter (**G**, **S**, **P**, or **W**) to the end of the item number. E.g. ST12**S**.

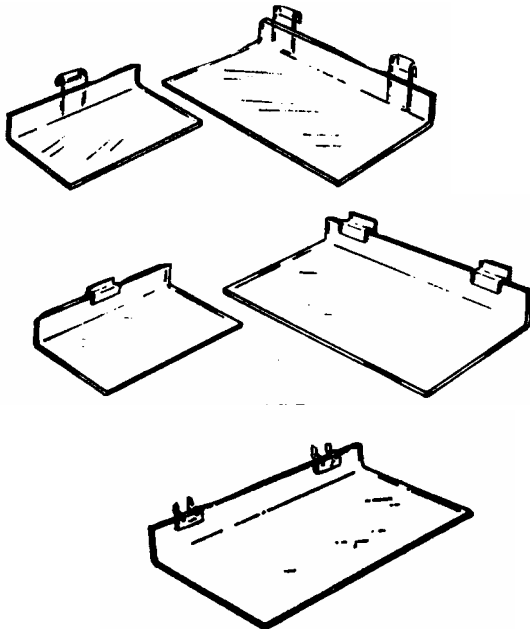

<u>Item</u>	<u>W x D</u>	<u>Price</u>	<u>Min. order</u>
XS01	9 x 4	5.82	6
XS02	10 x 4	5.86	6
XS05	12 x 4	6.51	6
XS06	12 x 6	7.77	6
XS07	12 x 8	9.69	6
XS09	16 x 8	10.82	6
XS11	24 x 8	15.15	6
XS13	16 x 12	17.19	6
XS14	16 x 6	10.33	6
XS15	24 x 12	24.23	6

BRACED STRAIGHT SHELVES

Made from 1/4" clear acrylic.

Available for **Gridwall**, **Slatwall**, **Pegboard**, or **Wall mount** . Add a letter (**G**, **S**, **P**, or **W**) to the end of the item number. E.g. ST12**S**.

<u>Item</u>	<u>W x D</u>	<u>Price</u>	<u>Min. order</u>
BT49	11 1/4 x 5 3/4	10.80	6
BT50	7 3/4 x 10	10.65	6
BT51	9 x 6	8.64	6
BT52	12 x 12	15.14	6
BT53	24 x 12	30.28	6
BT54	36 x 12	45.55	6

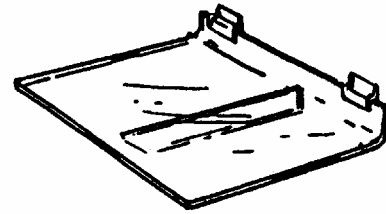

BRACED ANGLED STRAIGHT SHELVES

Made from 3/16" clear acrylic and had 45 deg tilt with 1 1/4" front lip.

Available for **Gridwall**, **Slatwall**, **Pegboard**, or **Wall mount** . Add a letter (**G**, **S**, **P**, or **W**) to the end of the item number. E.g. ST12**S**.

<u>Item</u>	<u>W x D</u>	<u>Price</u>	<u>Min. order</u>
BA54	6 3/4 x 11 1/2	12.35	6
BA55	10 x 10	16.88	6
BA56	12 x 6 3/4	8.82	6
BA57	16 x 10	18.40	6
BA58	20 1/2 x 13 1/2	26.46	6
BA59	24 x 12	34.13	6

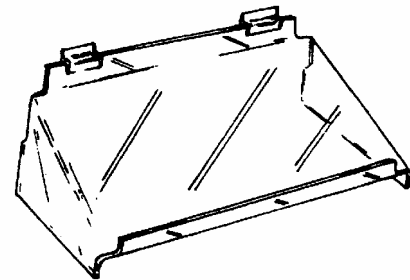

ANGLED FACE OUT SHELVES

Made from 1/4" clear acrylic and had 45 deg tilt with 1 1/4" front lip.

Available for **Gridwall**, **Slatwall**, **Pegboard**, or **Wall mount** . Add a letter (**G**, **S**, **P**, or **W**) to the end of the item number. E.g. ST12**S**.

<u>Item</u>	<u>W x D</u>	<u>Price</u>	<u>Min. order</u>
AF85	3 x 10	6.18	6
AF87	7 x 10	9.80	6
AF90	11 x 10	11.61	6
AF94	16 x 12	17.32	6
AF96	23 x 11	23.19	6
AF98	9 x 13	11.26	6
AF50	30 x 13	37.00	6

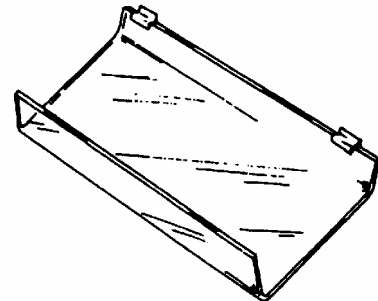

SHELF BLANKS

<u>Item</u>	<u>W x D</u>	<u>Price</u>	<u>Min. order</u>	1/4" Clear Acrylic
FB24	24 x 8	9.44	6	
FB25	24 x 10	11.78	6	
FB48	48 x 10	23.64	6	
FB26	24 x 12	14.20	6	
FB49	48 x 12	28.39	6	

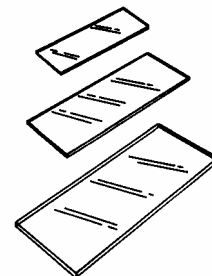

90 DEG FLAT SHELVES

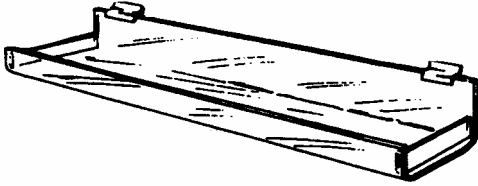

Available for **Gridwall**, **Slatwall**, **Pegboard**, or **Wall mount** . Add a letter (**G**, **S**, **P**, or **W**) to the end of the item number. E.g. ST12S.

ITEM	<u>W x D</u>		<u>Price</u>	<u>Min. order</u>
CS61	11 3/4 x 4	Open Ends	9.91	6
CS62	11 3/4 x 4	Closed Ends	13.65	6
CS63	23 3/4 x 4	Open Ends	19.99	6
CS64	23 3/4 x 4	Closed Ends	23.03	6

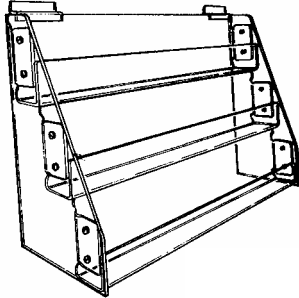

CARD RACK DISPLAY

Available for **Gridwall**, **Slatwall**, **Pegboard**, or **Wall mount** . Add a letter (**G**, **S**, **P**, or **W**) to the end of the item number. E.g. ST12S. Ships unassembled.

ITEM	<u>H x W x D</u>		<u>Price</u>	<u>Min. order</u>
GC38	13 3/8 x 21 1/4 x 7 1/4	Three Tier	45.88	4
GC48	17 3/4 x 21 1/4 x 9 1/2	Four Tier	56.47	4

FLANGED STAIR

Good for displaying boxed or packaged items. Also works well for cards.

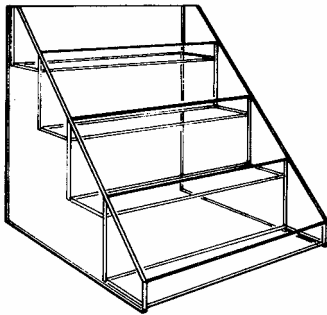

<u>Item</u>	<u>H x W x D</u>	<u>Stair Depth</u>	<u>Price</u>	<u>Min. order</u>
SD69	8 1/4 x 10 1/4 x 8 1/8	1 3/4	30.62	4
SD70	9 x 12 1/2 x 9 1/4	2	33.65	4
SD74	10 x 10 3/16 x 11	2 1/2	35.70	4
SD78	13 x 12 1/4 x 13	3	41.58	4
SD79	13 x 18 x 13	3	48.51	4
SD80	17 1/2 x 19 x 17 1/2	3 7/8	55.13	4

REVERSABLE STAIR

These stairs are designed to be used two ways.

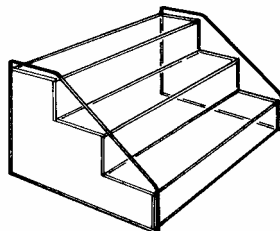
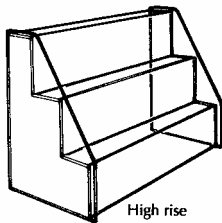

<u>Item</u>	<u>H x W x D</u>	<u>Stair Depth</u>	<u>Price</u>	<u>Min. order</u>
SD84	8 x 12 1/4 x 6 1/2	2 or 2 1/2	35.28	4
SD85	9 x 14 1/4 x 6 1/2	2 or 3	38.22	4
SD86	11 x 18 1/2 x 7 3/4	2 1/2 or 3 1/2	42.62	4

MULTI-TIER SHELVES FOR GREETING

Available for **G**ridwall, **S**latwall, **P**egboard, or **W**all mount . Add a letter (**G**, **S**, **P**, or **W**) to the end of the item number. E.g. ST12**S**.

<u>Item</u>	<u>H x W x D</u>		<u>Price</u>	<u>Min. order</u>
MG51	9 3/4 x 24 x 4	Three Tier	65.43	4
MG52	9 3/4 x 48 x 4	Three Tier	103.00	4
MG54	11 x 24 x 5	Four Tier	86.04	4
MG53	11 x 48 x 5	Four Tier	132.09	4

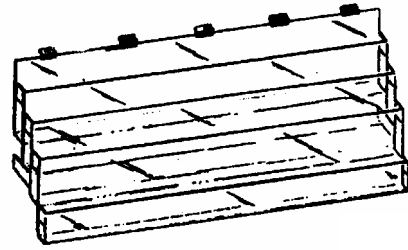



BODY FORMS

Made from 1/8" clear acrylic. Can be used with rod peg to hang on wall.

<u>Item</u>	<u>H x W</u>	<u>Price</u>	<u>Min. order</u>
YF15	28 1/2 x 17 3/4	22.85	4

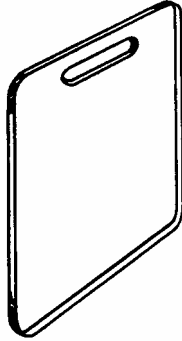

FOLDING BOARDS

Made from 1/8" clear acrylic.

<u>Item</u>	<u>H x W</u>	<u>Price</u>	<u>Min. order</u>
FL01	12 x 8 1/2	4.06	12
FL02	12 x 10	4.49	12
FL03	12 x 11	5.42	12

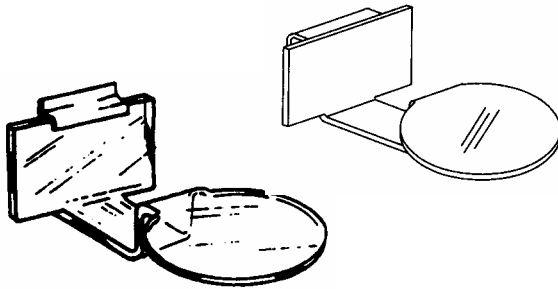

HAT DISPLAYS

Available for Gridwall, Slatwall, Pegboard, or Wall mount . Add a letter (**G**, **S**, **P**, or **W**) to the end of the item number. E.g. ST12**S**.

<u>Item</u>	<u>H x W x D</u>	<u>Price</u>	<u>Min. order</u>
HD60	7 x 5 x 13	13.06	12

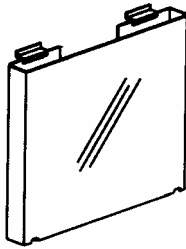

T-SHIRT DISPLAY

Available for Gridwall, Slatwall, Pegboard, or Wall mount . Add a letter (**G**, **S**, **P**, or **W**) to the end of the item number. E.g. ST12**S**.

<u>Item</u>	<u>H x W x D</u>	<u>Price</u>	<u>Min. order</u>
TD26	14 x 14 x 1 1/2	21.61	12

ROD PEG

Made from 1" diameter rod with end cap.

Available for Gridwall, Slatwall, Pegboard, or Wall mount . Add a letter (**G**, **S**, **P**, or **W**) to the end of the item number. E.g. ST12**S**.

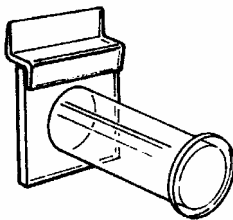

<u>Item</u>	<u>H x W x D</u>	<u>Price</u>	<u>Min. order</u>
RP01	1 1/2	4.74	12
RP03	3	5.08	12
RP04	4 1/2	5.42	12
RP06	6	6.09	12

WIDE OPENING EASELES

Good for purses and bags

<u>Item</u>	<u>H x W</u>	<u>Opening</u>	<u>Price</u>	<u>Min. order</u>
WE59	3 1/2 x 3 x 1/2	3	2.44	6
WE61	5 1/2 x 3 1/2	3	3.33	6
WE63	6 x 5 1/2	3	5.60	6
WE65	8 x 7 1/2	3	99.50	6
WE73	4 x 3 1/2	3	2.68	6
WE74	4 x 3 1/2	2	2.44	6

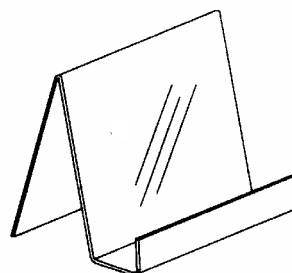

WIDE OPENING TILT EASELES

Good for purses and bags. Has 3" front lip and 3" opening, with 20 deg tilt.

Available for **Gridwall**, **Slatwall**, **Pegboard**, or **Wall mount** . Add a letter (**G**, **S**, **P**, or **W**) to the end of the item number. E.g. ST12**S**.

<u>Item</u>	<u>H x W</u>	<u>Price</u>	<u>Min. order</u>
WE46	13 x 8	12.70	6

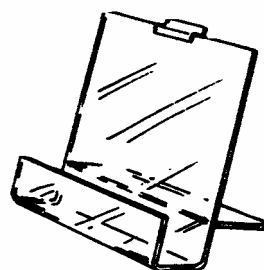

HOSIERY BINS

Available for **Gridwall**, **Slatwall**, **Pegboard**, or **Wall mount** . Add a letter (**G**, **S**, **P**, or **W**) to the end of the item number. E.g. ST12**S**.

<u>Item</u>	<u>H x W x D</u>		<u>Price</u>	<u>Min. order</u>
HB20	4 1/2 x 7 3/4 x 4 1/2	Single	14.12	6
HB21	4 1/2 x 15 1/2 x 4 1/2	Double	20.24	6

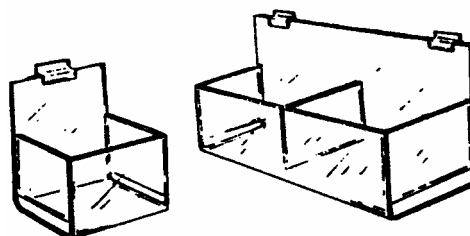

DOUBLE-WIDE TIERED BINS

These two and three level displays have compartments that are 4" high x 4" deep x 7 1/2" wide.

Available for **Gridwall**, **Slatwall**, **Pegboard**, or **Wall mount** . Add a letter (**G**, **S**, **P**, or **W**) to the end of the item number. E.g. ST12**S**.

<u>Item</u>	<u>H x W x D</u>		<u>Price</u>	<u>Min. order</u>
DW02	8 5/8 x 15 1/2 x 9	Two tier	33.85	6
DW03	12 3/8 x 15 1/2 x 13	Three tier	48.74	6

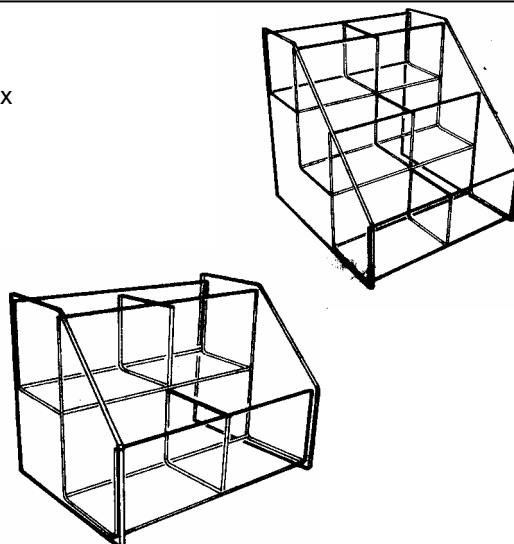

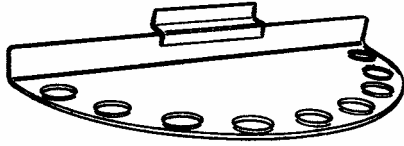

SCARF DISPLAY

Semi-circle holds 9 scarves. Holes are 1" diameter.

Available for **Gridwall**, **Slatwall**, **Pegboard**, or **Wall mount** . Add a letter (**G**, **S**, **P**, or **W**) to the end of the item number. E.g. ST12**S**.

<u>Item</u>	<u>H x W x D</u>	<u>Price</u>	<u>Min. order</u>
SF44	1 x 14 x 6 1/2	7.30	6

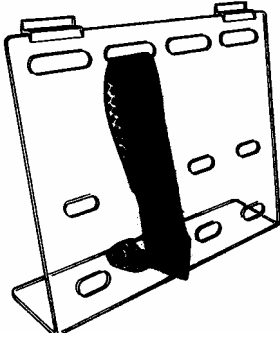

NECKTIE DISPLAY

Shows four folded neckties.

Available for **Gridwall**, **Slatwall**, **Pegboard**, **Wall mount** or **Counter**. Add a letter (**G**, **S**, **P**, **W**, or **C**) to the end of the item number. E.g. ST12**S**.

<u>Item</u>	<u>H x W x D</u>	<u>Price</u>	<u>Min. order</u>
ND19	13 1/2 x 19 x 4 1/4	18.61	6

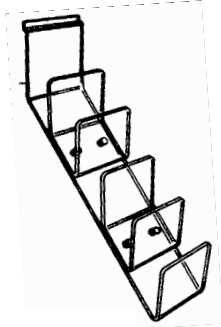

MULIT-CLUTCH-BAG DISPLAY

Displays 5 overlapping bags, wallets, etc. Pockets are 2 1/2" deep.

Available for **Gridwall**, **Slatwall**, **Pegboard**, or **Wall mount** . Add a letter (**G**, **S**, **P**, or **W**) to the end of the item number. E.g. ST12**S**.

<u>Item</u>	<u>H x W x D</u>	<u>Price</u>	<u>Min. order</u>
MC13	13 x 4 x 9 1/4	13.44	4

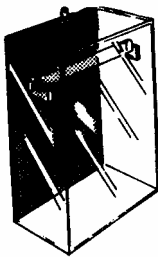

NECKLACE SHOWCASE

Has removable bar for displaying chains and necklaces. Back panel slides out.

<u>Item</u>	<u>H x W x D</u>	<u>Price</u>	<u>Min. order</u>
SW69	15 x 10 x 5	82.30	2

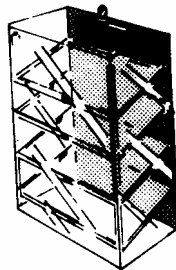

ANGELED SHELF SHOWCASE

Has 4 angled shelves for displaying boxed jewelry. Back panel slides out.

<u>Item</u>	<u>H x W x D</u>	<u>Price</u>	<u>Min. order</u>
SW70	15 x 10 x 5	105.66	2

EARRING DISPLAYS

Available for **G**ridwall, **S**latwall, **P**egboard, **W**all mount or **C**ounter. Add a letter (**G**, **S**, **P**, **W**, or **C**) to the end of the item number. E.g. ST12**S**.

<u>Item</u>	<u>H x W</u>	<u>Price</u>	<u>Min. order</u>
ED15	15 x 15	24.48	4

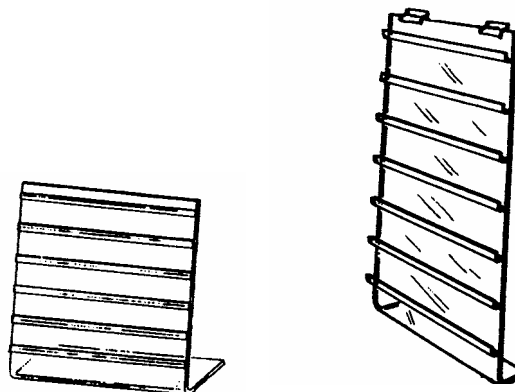

LOCKING COUNTERTOP

<u>Item</u>	<u>H x W x D</u>	<u>Price</u>	<u>Min. order</u>
SW63	6 x 24 x 18	102.19	2
SW64	3 x 24 x 18	85.06	2

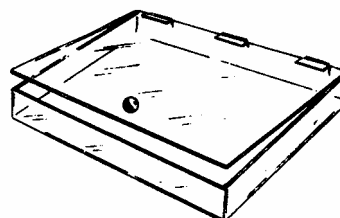

T-BARS

Available for **G**ridwall, **S**latwall, **P**egboard, or **W**all mount . Add a letter (**G**, **S**, **P**, or **W**) to the end of the item number. E.g. ST12**S**.

<u>Item</u>	<u>W x D</u>	<u>Price</u>	<u>Min. order</u>
TN08	8 x 4	15.36	6
TN15	15 1/2 x 4	18.64	6

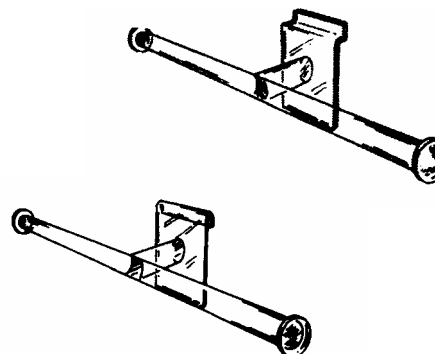

COUNTER T-BARS

<u>Item</u>	<u>H x W x D</u>		<u>Price</u>	<u>Min. order</u>
TN01	6 1/4 x 8 x 2	One Tier	15.92	4
TN02	8 1/4 x 8 x 5	Two Tier	24.99	4
TN03	10 3/4 x 8 x 8	Three Tier	33.32	4

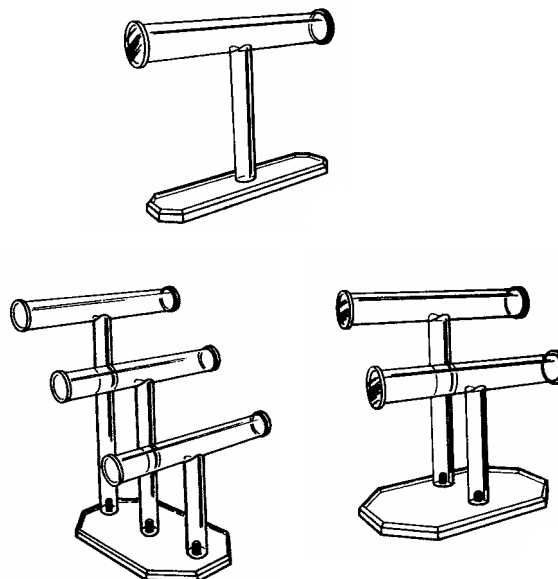

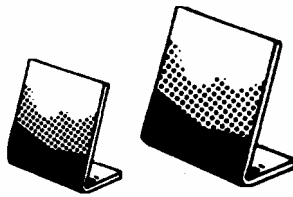

SLANT BACK MIRROR

<u>Item</u>	<u>H x W</u>	<u>Price</u>	<u>Min. order</u>
RM07	7 x 5 1/4	4.23	6
RM12	12 x 9	9.70	6
RM18	18 x 12	34.05	4



WALL MIRROR

Available for **Gridwall**, **Slatwall**, **Pegboard**, or **Wall mount** . Add a letter (**G** , **S** , **P** , or **W**) to the end of the item number. E.g. ST12**S**.

<u>Item</u>	<u>H x W</u>	<u>Price</u>	<u>Min. order</u>
RM10	10 x 8	8.50	6
RM14	14 x 10	12.55	6



THREE-WAY ACRYLIC MIRRORS

<u>Item</u>	<u>H x W x D</u>	<u>Panel Size</u>	<u>Price</u>	<u>Min. order</u>
RM33	4 x 10 x 3 1/2	4 x 4	6.02	4
RM77	7 x 16 x 6	7 x 7	12.48	4
RM55	10 x 12 x 4 1/2	10 x 5	14.29	4

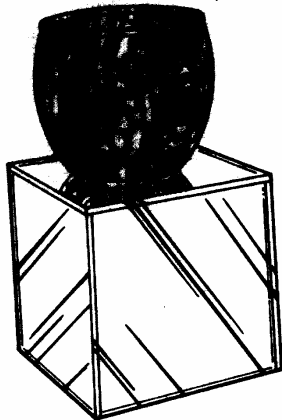

MIRRORED CUBES

Mirrored on five sides.

<u>ITEM</u>	<u>H x W x D</u>	<u>Price</u>	<u>Min. order</u>
RM44	4 x 4 x 4	15.30	4
RM66	6 x 6 x 6	19.22	4
RM88	8 x 8 x 8	27.86	4
RM11	10 x 10 x 10	42.35	4
RM22	12 x 12 x 12	56.83	4
RM46	4 x 6 x 4	19.50	4
RM69	6 x 9 x 6	27.86	4
RM82	8 x 12 x 8	33.43	4

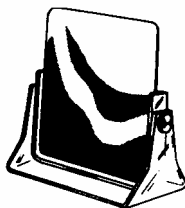

ADJUSTABLE MIRROR

Has 8" x 10" mirror

<u>ITEM</u>	<u>H x W x D</u>	<u>Price</u>	<u>Min. order</u>
RM13	11 x 10 x 3	25.76	2

THREE SHELF INTERLOCKING TOWER

The three shelves of this display are constructed with slotted "V" supports, which also provide areas for the shelves. Shipped unassembled. Space between shelves is 6".

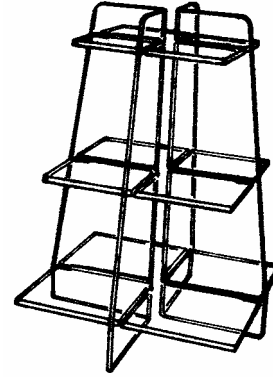

<u>Item</u>	<u>H x W x D</u>	<u>Price</u>	<u>Min. order</u>
CR16	16 x 12 x 12	44.23	2

THREE SHELF INTERLOCKING DISK RISER

Shipped unassembled.

<u>Item</u>	<u>H x W x D</u>	<u>Space Between</u>	<u>Platform Size</u>	<u>Price</u>	<u>Min. order</u>
CR01	6 3/4 x 4 x 5 3/4	2 5/8	4, 3 1/2, 3	7.84	2
CR02	9 x 5 x 7 5/8	3 3/8	5, 4 3/8, 3 3/4	10.92	2
CR03	11 x 6 x 8 3/4	4	6, 5 1/4, 4 1/2	15.75	2
CR04	13 x 7 1/2 x 10 3/4	5	7 1/2, 6, 4 1/2	21.97	2
CR05	15 1/8 x 9 x 12 1/2	6	9, 7 1/2, 6	27.93	2

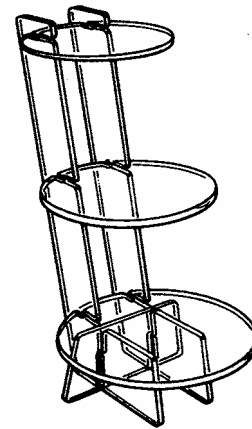

FOUR SHELF INTERLOCKING DISK RISER

Shipped unassembled.

<u>Item</u>	<u>H x W x D</u>	<u>Space Between</u>	<u>Platform Size</u>	<u>Price</u>	<u>Min. order</u>
CR06	18 1/2 x 9 x 13 1/2	5	9, 7 1/2, 6, 4 1/2	32.56	2
CR07	21 1/2 x 10 1/2 x 14 1/2	6	10 1/2, 9, 7 1/2, 6	38.37	2

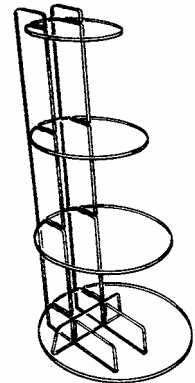

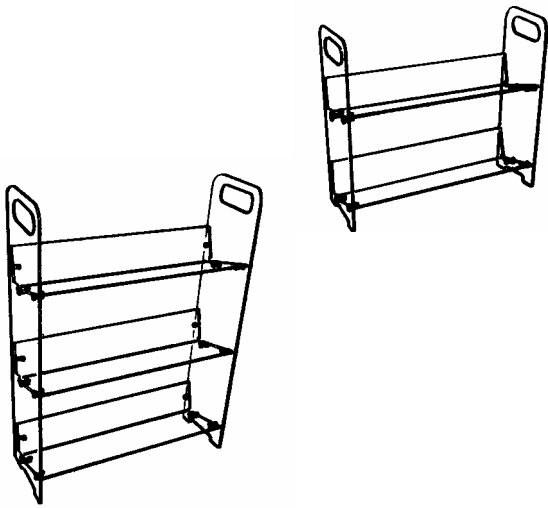

SHELF UNIT

Made of heavy 1/4" thick acrylic. Shipped unassembled.

<u>Item</u>	<u>H x W x D</u>		<u>Price</u>	<u>Min. order</u>
CR22	21 1/4 x 24 1/2 x 8 1/4	Two Shelves	58.68	2
CR33	31 1/2 x 24 1/2 x 8 1/4	Three Shelves	78.55	2

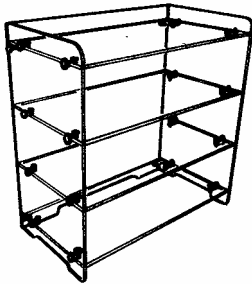

FLAT SHELF UNIT

Made of heavy 1/4" thick acrylic. Shipped unassembled.

<u>Item</u>	<u>H x W x D</u>		<u>Price</u>	<u>Min. order</u>
CR42	18 x 18 1/2 x 9 3/4	Flat front	92.27	2
CR44	18 x 18 1/2 x 11 1/2	Angled Front	92.27	2

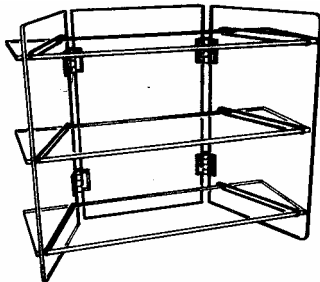
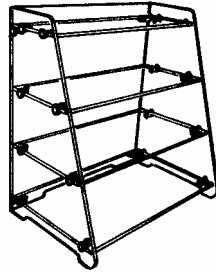

FOLDING SHELF UNIT

Acrylic shelves slide in to slotted panels. Shipped unassembled.

<u>Item</u>	<u>H x W x D</u>		<u>Price</u>	<u>Min. order</u>
CR53	11 1/4 x 14 1/2 x 6 5/8	Three Shelf	41.63	2
CR63	14 x 18 x 8 1/4	Three Shelf	48.86	2
CR73	20 x 20 x 9 1/2	Three Shelf	72.75	2
CR74	24 x 24 x 10 1/4	Four Shelf	78.67	2

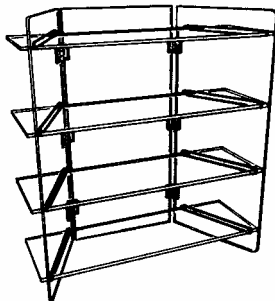

ANGLED FRONT CABINET

Made from 3/16" thick acrylic.

<u>Item</u>	<u>H x W x D</u>	<u>Price</u>	<u>Min. order</u>
CF14	8 x 18 1/2 x 14	77.18	4

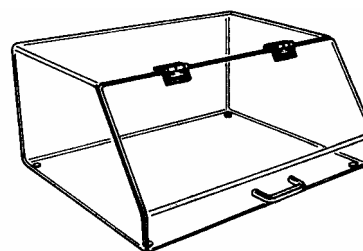

DISPLAY TRAYS

Made from 3/16 acrylic

<u>Item</u>	<u>H x W x D</u>	<u>Price</u>	<u>Min. order</u>
DT01	1 1/4 x 6 x 9	6.30	12
DT02	1 1/4 x 6 x 12	7.32	12
DT03	1 1/4 x 8 x 10	8.38	12
DT04	1 1/4 x 8 x 12	9.78	12
DT05	2 1/4 x 8 x 12	11.34	12
DT06	1 x 1/4 x 8 x 15	9.14	12
DT07	2 x 9 x 12	12.60	12

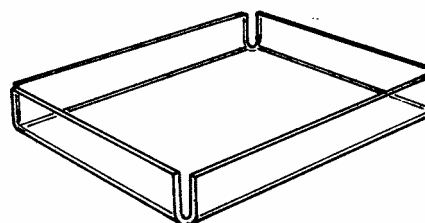

STACKABLE BULK BINS

Three sizes can be used alone or together, stacked as a graduated unit or using the same unit on top of itself .

<u>Item</u>	<u>H x W x D</u>	<u>Price</u>	<u>Min. order</u>
FP11	9 7/8 x 8 x 11 1/4	42.27	4
FP16	9 7/8 x 8 x 16 1/4	53.66	4
FP21	9 7/8 x 8 x 21 1/4	61.40	4

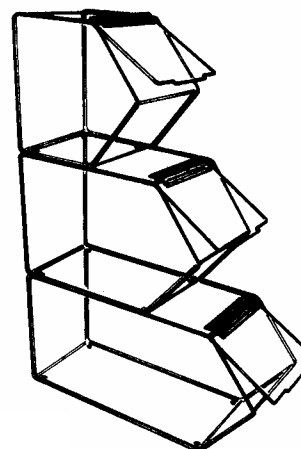

STACKABLE BAGLE BINS

Larger size bulk bin is excellent for bagels as well as many other bulk foods.

<u>Item</u>	<u>H x W x D</u>	<u>Price</u>	<u>Min. order</u>
FP88	12 x 12 x 11 1/2	50.40	4
FP89	12 x 12 x 18	58.80	4

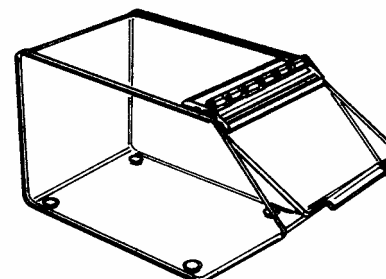

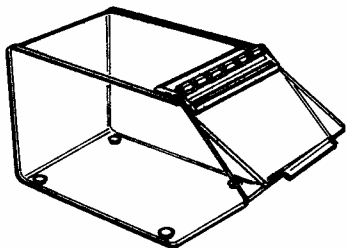

MINI STACKABLE BINS

Made from 3/16" thick acrylic. These bins work well for small candies, ice-cream toppings, etc. These bins stack on top of each other.

<u>Item</u>	<u>H x W x D</u>	<u>Price</u>	<u>Min. order</u>
FP10	5 x 5 x 9 1/2	18.38	4

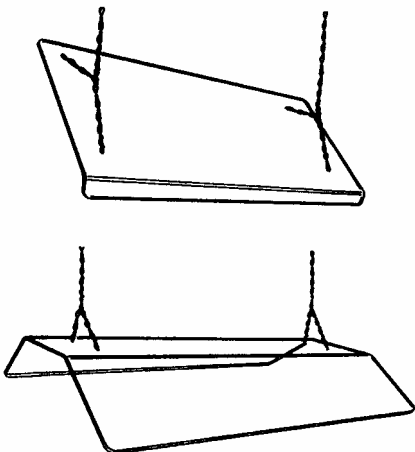

SNEEZE GUARDS

Made of heavy 1/4" thick acrylic.

<u>Item</u>	<u>H x W x D</u>		<u>Price</u>	<u>Min. order</u>
FZ20	19 x 48 x 16	Single Side	94.64	1
FZ30	19 x 60 x 16	Single Side	106.47	1
FZ40	19 x 72 x 16	Single Side	113.57	1
FZ50	7 x 48 x 30 1/2	Double Side	141.96	1
FZ60	7 x 60 x 30 1/2	Double Side	150.83	1
FZ70	7 x 72 x 30 1/2	Double Side	170.35	1

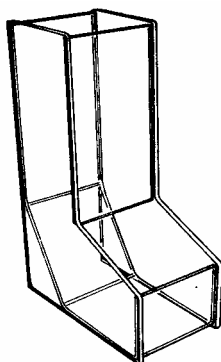

GRAVITY-FEED PACKET DISPENSER

Single, double, and quadruple wide versions. Top and dispensing area are open.

<u>ITEM</u>	<u>H x W x D</u>		<u>Price</u>	<u>Min. order</u>
FG04	12 x 4 3/8 x 8 1/4	Single	24.37	4
FG08	12 x 8 5/8 x 8 1/4	Double	38.99	4
FG17	12 x 17 x 8 1/4	Quadruple	58.48	4

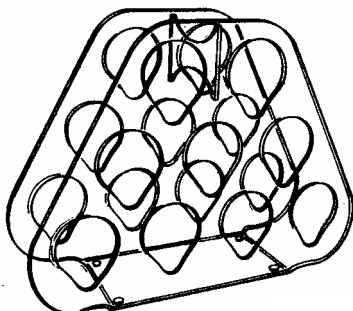

WINE BOTTLE DISPLAY

<u>Item</u>	<u>H x W x D</u>	<u>Bottles</u>	<u>Price</u>	<u>Min. order</u>
WI11	11 1/2 x 17 x 6 1/2	Five	39.94	2
WI16	16 x 21 1/2 x 6 1/2	Nine	53.24	2

ACRYLIC CLEANING SUPPLIES

Brillinize cleaner This spray cleans without scratching and help to repel dust, static, and finger prints.

<u>Item</u>	<u>Size</u>	<u>Price</u>	<u>Min. order</u>
AC08	8 oz		1
AC28	128 oz		1



NOVAS NO. 2 This paste can remove fine scratches, haziness, and abrasions from most plastics.

<u>Item</u>	<u>Size</u>	<u>Price</u>	<u>Min. order</u>
AC02	8 oz		1



NOVAS NO. 3 To remove heavy scratches and abrasions from most plastic, this paste requires use of Novas No. 2 for a final finish.

<u>Item</u>	<u>Size</u>	<u>Price</u>	<u>Min. order</u>
AC03	8 oz		1



POLISH MATES CLEANING CLOTHS

Disposable cloths made especially for cleaning acrylic are low lint, abrasion resistant, and durable

<u>Item</u>	<u>Size</u>	<u>Price</u>	<u>Min. order</u>
PM25	Pack of 6		1

SINTRA LETTERS

Sintra letters offer a satin face in standard colors or can be painted any standard or custom color. Good for interior use (must be painted for exterior use).

SINTRA	2"	3"	4"	6"	8"	10"	12"	14"	16"	18"	20"	24"
1/8" Thick												
Unpainted : Black , White	2.46	2.71	2.96	3.73	5.26	7.12	8.64	11.10	13.98	16.94	20.08	23.21
Painted	3.38	3.73	4.98	5.12	7.22	9.78	11.88	15.26	19.22	23.29	27.60	31.91
1/4" Thick												
Unpainted : Black , White	3.38	3.82	4.57	5.59	8.14	11.18	14.15	18.30	22.28	26.42	30.66	37.78
Painted	4.66	5.24	6.29	7.69	11.18	15.37	19.45	25.16	30.64	36.75	42.17	51.95
1/2" Thick												
Unpainted : Black, White	5.23	6.07	7.20	9.24	12.58	16.30	20.92	26.45	30.62	36.60	44.29	57.83
Painted	6.53	7.58	9.00	11.56	15.49	20.37	26.15	32.59	38.28	43.96	52.10	74.12
3/4" Thick												
Unpainted : Black, White	7.53	8.74	10.43	13.32	18.11	23.54	29.18	36.95	42.76	51.14	61.36	85.50
Painted	9.00	10.43	12.45	15.90	21.62	28.09	35.02	44.34	51.31	61.36	73.64	102.60
1" Thick												
Unpainted : Black, White	10.55	12.23	14.60	18.65	25.35	32.95	40.85	51.74	59.86	71.59	85.91	119.70
Painted	12.60	14.60	17.43	22.26	30.27	39.32	49.03	62.08	71.83	85.91	103.09	143.64

ACRYLIC LETTERS

Acrylic letters offer a high-gloss face in standard colors (white, black, dark blue, light blue, red, green, yellow) or can be painted any standard or custom color. Good for interior or exterior use.

Our Acrylic letters are precision cut w/ lasers and have highly polished edges. We can also cut letters & logos that are very intricate & small. Laser cut letters are react poorly when solvent glued. Please specify routed letters if you plan to solvent glue or solvent paint the letters.

Acrylic	2"	3"	4"	6"	8"	10"	12"	14"	16"	18"	20"	24"
1/8" Thick												
Unpainted : Standard colors	2.61	2.88	3.15	3.96	5.58	7.56	9.18	11.79	14.85	18.00	21.33	28.17
Painted	3.39	3.74	4.10	5.15	7.25	9.83	11.93	15.33	19.31	23.40	27.73	40.24
1/4" Thick												
Unpainted : Standard colors	3.60	4.05	4.86	5.94	8.64	11.88	15.03	19.44	23.67	28.08	32.58	46.17
Painted	4.68	5.27	6.32	7.72	11.23	15.44	19.54	25.27	30.77	36.50	42.35	65.96
1/2" Thick												
Unpainted : Black, White	6.21	7.20	8.55	10.98	14.94	19.35	24.84	31.41	36.36	43.47	52.20	72.72
Painted	7.45	8.64	10.26	13.18	17.93	23.22	29.81	37.69	43.63	52.16	62.64	103.89

GATORFOAM LETTERS

Gatorfoam letters offer economical look with added dimension and light weight. Available in standard or custom painted colors. Recommended for interior use.

Gatorfoam	2"	3"	4"	6"	8"	10"	12"	14"	16"	18"	20"	24"
Painted												
3/16", 1/2", 3/4" hick	4.30	4.46	5.36	7.55	9.50	12.82	15.39	19.32	23.24	25.96	30.90	43.31
1" Thick	4.73	4.90	5.89	8.30	10.45	14.10	16.93	21.25	25.57	28.56	33.99	47.64
1-1/2" Thick	5.38	5.57	6.70	9.44	11.88	16.02	19.24	24.15	29.05	32.45	38.62	54.13
2" Thick	5.59	5.80	6.96	9.81	12.35	16.67	20.01	25.11	30.22	33.75	40.17	56.30
15 % off for unpainted letters												

METAL FACE SINTRA LETTERS

Metal faced sintra letters offer a upscale look with out the cost of solid metal letters. Available in brushed gold, polished gold, brushed silver, polished silver, and brushed copper

Metal Face PVC	2"	3"	4"	6"	8"	10"	12"	14"	16"	18"	20"	24"
Black or White Edge												
1/8" Thick	7.26	8.34	9.95	12.36	15.98	20.76	25.33	32.80	34.17	43.71	55.76	68.81
1/4" Thick	7.78	8.66	10.24	13.37	17.61	24.31	30.65	37.32	39.02	49.97	63.14	77.69
1/2" Thick	9.71	10.97	12.83	17.01	22.67	30.68	38.34	47.27	51.14	64.34	79.82	98.24
3/4" Thick	11.66	13.28	15.44	20.64	27.74	37.06	46.04	57.22	63.26	78.72	96.50	118.79
1" Thick	13.99	15.93	18.52	24.77	33.28	44.47	55.24	68.66	75.92	94.46	115.80	142.54
Add 10% for painted edges												

METAL FACE GATORFOAM LETTERS

Metal faced gatorfoam letters offer a upscale look with added diemition. Available in brushed gold, polished gold, brushed silver, polished silver, and brushed copper

Metal Face Gatorfoam	2"	3"	4"	6"	8"	10"	12"	14"	16"	18"	20"	24"
Black or White Edge												
3/16", 1/2", 3/4" hick	8.15	8.68	9.68	12.30	17.81	24.00	28.92	45.19	45.26	56.30	66.17	82.45
1" Thick	8.97	9.54	10.65	13.53	19.59	26.40	31.81	49.71	49.79	61.92	72.78	90.69
1-1/2" Thick	9.78	10.41	11.62	14.76	21.37	28.80	34.70	54.23	54.31	67.55	79.40	98.94
2" Thick	10.19	10.85	12.11	15.38	22.26	30.00	36.15	56.49	56.58	70.37	82.71	103.06
Add 10% for painted edges												

LAMINATED SINTRA LETTERS

Laminated face sintra letters offer a durable satin face. Available in any standard or custom laminate.

Laminate Face PVC	2"	3"	4"	6"	8"	10"	12"	14"	16"	18"	20"	24"
Black or White Edge												
1/8" Thick	5.81	6.67	7.96	9.89	12.78	16.61	20.26	26.24	27.34	34.97	44.60	55.04
1/4" Thick	6.22	6.92	8.19	10.69	14.09	19.45	24.52	29.86	31.22	39.97	50.51	62.15
1/2" Thick	7.77	8.77	10.27	13.61	18.14	24.55	30.67	37.81	40.91	51.47	63.86	78.59
3/4" Thick	9.32	10.62	12.35	16.51	22.19	29.65	36.83	45.77	50.61	62.98	77.20	95.03
1" Thick	11.19	12.74	14.82	19.81	26.63	35.58	44.19	54.93	60.73	75.57	92.64	114.03

Add 10% for painted edges

LAMINATED FACE GATORFOAM LETTERS

Laminated face gatorfoam letters offer a durable satin face with added dimension. Available in any standard or custom laminate.

Laminate Face Gator-foam	2"	3"	4"	6"	8"	10"	12"	14"	16"	18"	20"	24"
Black or White Edge												
3/16", 1/2", 3/4" hick	5.26	5.87	6.77	7.91	10.01	12.68	15.87	22.10	22.17	24.74	28.49	37.29
1" Thick	5.78	6.45	7.45	8.70	11.01	13.95	17.46	24.31	24.39	27.22	31.33	41.02
1-1/2" Thick	6.05	6.75	7.79	9.11	11.51	14.59	18.25	25.42	25.49	28.46	32.76	42.88
2" Thick	6.57	7.33	8.47	9.89	12.51	15.85	19.84	27.63	27.71	30.93	35.61	46.61

Add 10% for painted edges

SOLID ALUMNUMINUM LETTERS

Solid aluminum letters offer unsurpassed durability. Great for exterior use. Available raw or custom painted.

Solid Aluminum	2"	3"	4"	6"	8"	10"	12"	14"	16"	18"	20"	24"
1/8" Thick, Raw Finish	6.68	8.18	9.68	12.23	14.63	17.85	21.75	27.90	36.90	45.90	56.10	77.10
1/4" Thick, Raw Finish	8.85	10.80	13.13	18.00	21.75	25.50	29.78	35.03	41.93	50.48	62.70	89.25

Add 25%, Plus paint mix charge of \$65.00 for painted letters

VINYL LETTERS

Ready to apply cut vinyl letters are available in regular and reverse cut.

Vinyl	1/2"	1"	1-1/2"	2"	3"	4"	6"	8"	10"	12"	14"	16"
Standard colors	0.44	0.49	0.56	0.73	0.90	1.09	1.67	2.45	3.32	4.10	5.51	6.61
Reflective	0.60	0.98	1.13	1.46	1.80	2.18	3.33	4.91	6.65	8.21	11.03	13.22
Edgemark-Sandblasted look	0.60	0.98	1.13	1.46	1.80	2.18	3.33	4.91	6.65	8.21	11.03	13.22
Vinyl	18"	20"	22"	24"	26"	28"						
Standard colors	11.97	13.56	15.93	18.26	20.87	23.56						
Reflective	23.94	27.13	31.86	36.52	41.73	47.12						
Edgemark-Sandblasted look	23.94	27.13	31.86	36.52	41.73	47.12						

LASER ETCHING

We can laser etch photographs, text or graphics on a wide variety of materials. Acrylic, granite tile, marble tile, wood, glass, anodized aluminum, and engraving stock can all be laser etched to produce an unique upscale look. Color can be added to add a higher level of value. Some laser etched products include:

- Acrylic Awards
- Award Plaques
- Photograph
- Pet Memorials
- Wood plaques
- Directories
- Industrial Machine Labels
- Engraving Stock
- Edge Light Signs
- Glass
- Coated Metals

Laser etching prices do not include material or file setup. Please call for material pricing.

Laser etching service	>1sf	1-3sf	3-10sf	10-50sf
per sq/ft				
Etch	57.00	49.00	38.00	35.00
Etch w/ one color fill	65.50	56.50	44.50	41.00
Etch w/ two color fill	74.00	64.00	51.00	47.00

LASER CUTTING

We can also laser cut a wide range of materials. Our laser beam is .005" in diameter. This produces extremely precise and detailed cutting. All the inside and outside corner will be absolute square (see detail below) and acrylic edges will have a polished edge. Some materials that can be cut include:

- | | |
|--|---|
| Materials | Products. |
| <ul style="list-style-type: none"> • Acrylic (up to 1") • Wood (up to 1/2") • Paper • Gaskets • Cloth | <ul style="list-style-type: none"> • Leather • Mat Board • Styrene • Masonite • ABS • Letters • Logos • Stencils • Model Kits • Paper Scrap booking • Architectural Models • Business Cards • Inlay Products • Ad Specialty Items |

MOUNTING OPTIONS

Mounting Patterns		Two Way Tape		Studs	
<u>H x L</u>	<u>Price</u>	<u>Letter Height</u>	<u>Price</u>	<u>Letter Height</u>	<u>Price</u>
Up to 24" x 48"	17.00	Up to 8"	.83	Up to 8"	3.50
24" x 49"-72"	21.00	9" to 14"	1.49	9" to 14"	4.80
24" x 73"-96"	26.00	15"+	2.49	15"+	6.15

ART REQUIREMENTS

Send all files for orders or quote request to sales@newwaveacrylics.com

- * Include your name, company, and contact information.
- * Make sure that all text is converted to outlines, curves, graphics including descriptive text.
- * The art file should include the following information:
 - * Material / Color / Thickness
 - * Edges Painted
 - * Over All Size
 - * Mounting Method (tape / studs / plane)
 - * Paper Pattern
 - * Laminate type & Grain Direction
 - * Requested Completion Date
- * File type: We prefer Encapsulated Postscript (.eps) files, but we also accept Adobe Illustrator (.ai) Corel Draw (.cdr), Digital Exchange Format (.dxf), and Sign Lab (.cdl).

I