

www.arindustrial.co.za



AR INDUSTRIAL
QUALITY TOOLING SOLUTIONS FOR THE INDUSTRY

EVERLAST
INDUSTRIAL PRODUCTS



PPE, WELDING & FABRICATION CATALOGUE Volume 1

QUALITY TOOLING
SOLUTIONS FOR THE INDUSTRY



AR INDUSTRIAL

QUALITY TOOLING SOLUTIONS FOR THE INDUSTRY



QUALITY TOOLING SOLUTIONS FOR THE INDUSTRY

View our online catalogue at www.arindustrialcatalogue.co.za

Since 2003 AR Industrial has excelled in becoming one of South Africa's leading Industrial Supply Companies. Specialising in Engineering Tools, Power Tools, Welding Equipment and Consumables, Abrasives, Safety Equipment and Clothing, Construction Equipment, Industrial Machinery, Mining Equipment. To the Construction, Manufacturing, Mining, Engineering, Fabrication, Petro Chemical, Oil & Gas and Power Generation.



Importers and distributor of quality welders and operators work gloves and welding Consumables.



Our entire staff is highly trained with over 30 years combined engineering experience. The AR Industrial team is a powerful and motivated combination of a highly knowledgeable outside sales group with an inside sales staff that offers excellent in-house technical support in the engineering, construction & welding industry.

Teaming technical expertise with superior service, it is our mission to achieve complete customer satisfaction while delivering quality products, both standard and special, at competitive prices from reliable sources in an expedient manner. From the D-I-Y enthusiast to the largest contractor, our friendly sales staff will make sure you get the right tool to get the job done!

AR Industrial continues to be your industrial tool supplier serving Gauteng and beyond. We provide our customers with quality tooling solutions and competitive pricing.

As part of our growth strategy, we have extended our services throughout the African Continent. AR Industrial has established an Export Division which focuses Solely on the Mining & Engineering Industries.

AR Industrial is a 100% Black Owned Industrial Supply Company With a Level 2 BEE Status



www.arindustrial.co.za

INDUSTRIAL PPE - LEATHER GLOVES



CE  **EN 420**

Candy Stripe Leather Handling Glove

A Durable, hardwearing general handling glove made from high quality cow split leather. Lightweight & economical. Cow split leather palm, thumb, back, knuckle, pull & tips Half cotton lined.

Applications: General handling operators gloves

Order code - 200105



CE  **4132 EN 420**

Superior candy rigger leather glove

A hardwearing superior candy rigger glove made from high quality cow split leather. Wing thumb, rubberised cuff, reinforced double palm thumb & index finger for extra protection and durability. Safety cuff and knuckle bar for added protection.

Applications: General handling, rigging operations, Construction Fabrication, Maintenance and Mining.

Order code - 200110



CE  **3143 EN 388**

Chrome leather gloves double palm

A Grade quality heavy duty all-chrome leather glove. Tough and durable, Reinforced double palm and thumb. Perfect for tough industrial jobs, either indoors or outdoors. Available in wrist and elbow length

Applications: General handling, assembly, Construction, Fabrication Light Welding, Maintenance and Mining.

Order codes:
50mm 2" - 200115
200mm 8" - 200120



CE  **EN 388 4144**  **EN 407 413X4X**

Green Lined Welding Glove

High quality cow split leather glove with a cotton fleece lining. These gloves provide excellent protection against heat and welding sparks. Perfect for tough welding jobs. Perfect for MIG and ARC welding application. Available in wrist, elbow and shoulder lengths.

Applications: Welding, Construction, Steel Fabrication Maintenance, Mining and Foundry.

Order codes:
50mm 2" - 200125
200mm 8" - 200130
400mm 16" - 200135



INDUSTRIAL PPE - LEATHER GLOVES & CLOTHING



Red Heat Resistant Gloves

Red Premium Heat Resistant Glove with Apron Palm.
The Heat Resistant Glove is fully lined and sewn with KEVLAR®
Very good resistance to abrasion, tear, puncture and heat.
Perfect for tough high heat welding jobs.
Apron Palm provides increased thermal protection.

Applications: Welding, Foundry, Construction, Steel Fabrication
Maintenance, Smelter Work, Mining and Foundry.

CE EN 388 EN 407
4144 413X4X

Order codes:
200mm 8" - 200140



Tig welders glove vip

Excellent fit and feel for precision TIG welding.
Providing the highest degree of comfort, flexibility, as well as
abrasion resistance with shirred elastic back and wing thumb.

The **EVERLAST** TIG glove is designed for dexterity, durability and
comfort for soft touch tig welding.

Applications: TIG Welding, Construction, Material handling.

CE 4143 EN 388

Order codes:
50mm 2" - 200145



Chrome Leather Aprons

Apron are manufactured from very high grade leather providing
excellent body coverage for welding, grinding and tough applications.
It is designed to give protection from chest to knee.
Neck and waist straps are fully adjustable with a quick release buckle.
Leather is a extremely strong wearing and protects your workwear
not only from the hazards of welding but also abrasion, fluids and
general wear and tear.

Order codes:
60 x 90 1PC - 200150
60 x 90 2PC - 200155
60 x 120 - 200160



Chrome leather spats

All leather welder's spats are manufactured from the finest
hand picked leather hides for consistent quality and long wear.
They are designed to protect lower legs and shoes from welding spark
and spatter. The Spats are fully adjustable and are secured with Velcro.

Widely used in welding and Fabrication industries.

CE EN 470

Order code - 200165



INDUSTRIAL PPE - LEATHER GLOVES & CLOTHING



Chrome leather welders yokes

Made from heavy duty chrome split leather which is extremely durable, flame resistant and offers excellent protection from welding spatter. It is designed to protect the chest and arms from sparks and spatter. The leather is strong and flexible, and the special tanning process allows it to remain soft when continuously exposed to heat.

Widely used in welding and Fabrication industries.

Available from small to XXXL



EN 470

Order code: - 200170

CUT RESISTANT GLOVES



HPT

Ultimate Wet & Dry Grip
Order code: - 200190

HPT™ process creates a spongy, soft, durable, flexible coating that repels liquids to provide a firm wet or dry grip. Encapsulated air molecules provide an inherent vibration absorption feature.

Ideal for the shipping, plumbing, warehousing, materials handling and assembly industries.



4131



FLEX

Perfect Durability & Flexibility
Order code: - 200195

The all new Ninja Flex glove is an excellent all purpose glove. Features a 15 gauge, 100% nylon shell with a crinkle latex coating. Provides flexibility, elasticity, and Excellent general purpose handling glove that provides good abrasion and tear resistance. Can be utilised in the agriculture, recycling, shipping and durable goods industries.



3131



FORCE

Cut Level 5 Glove
Order code: - 200200

13 Gauge Dyneema/Synthetic Fiber/Fiberglass shell with gray Polyurethane coating providing up to 20 times better cut resistance than Aramid-based spun yarn. Excellent light weight cut-resistance glove that provides abrasion, tear and puncture resistance. Mechanical operations, motor industry and glass and ceramic industry.



4542



LITE

Extreme Tactile Sensitivity
Order code: - 200205

Ultralight Fashion grade Nylon shell with feather light Polyurethane coating. Excellent wet, dry & light oil grip. Approx 30% lighter than traditional Nylon/PU gloves, providing unparalleled tactile sensitivity. Excellent glove that provides grip and feel in daily handling tasks. Ideal for intricate assembly processes such as optics, microprocessors



3121



X4

Economical Cut Protection
Order code: - 200210

13 Gauge Synthetic Fiber/Fiberglass shell with Bi-Polymer coating providing unsurpassed softness and durability. Economical & Effective Cut Protection. CE/EN 388 Cut Level 4

Excellent economical cut-resistance glove that also provides good abrasion and tear resistance. Glass industry, canning and automotive assembly.



4431



STAR

Cut & Splash Protection
Order code: - 200215

Fully coated 27cm gauntlet Dyneema/Synthetic Fiber shell with Bi-Polymer coating providing unsurpassed softness and durability.

Excellent cut & splash protection with good tear and puncture properties. Agriculture, fishing, sheet metal, glass handling and waste disposal.



PVC GLOVES

A fabric reinforced PVC Dip coated PVC. The front section of the liner is made with light weight Normac and the back section is made with Interlock cotton.



General Red Pvc
Wrist 200220
Elbow 200225
Shoulder 200230



H/D Terry glove
Wrist 200235
Elbow 200240

Aldo available in extra H/D



Pvc Chip Palm
Wrist 200245

PPE - RESPIRATORY - EYE - FACE - HEARING

A respirator is a device designed to protect the wearer from inhaling harmful dusts, fumes, vapors, or gases. Respirators come in a wide range of types and sizes used by the Engineering and Industrial industries. All respirators meet the European Standard EN149:2001 in FFP1, FFP2, and FFP3 classes of filter efficiency.

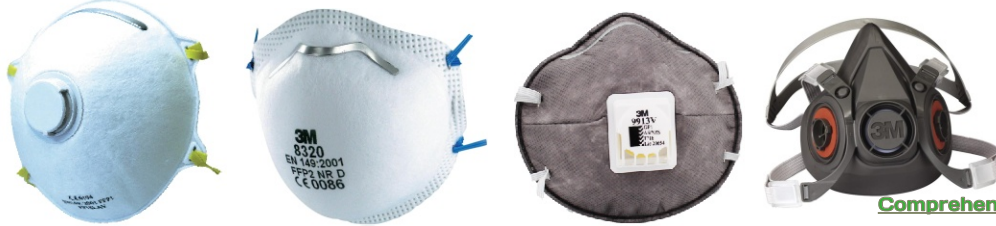

FFP1
FFP2
FFP2 VALVED
FFP2 ACTIVE CARBON VALVES
FFP3 VALVED
DOUBLE & SINGLE RESPIRATORS
RESPIRATORS CARTRIDGE FILTERS

[Comprehensive Catalogue's Available on Request](#)



EYE AND FACE PROTECTION

Eye injuries are about the easiest of injuries to avoid. It's simple: Wear Your Eye Protection. There are many kinds of eye protection on the market today. No matter what the application, where eye safety is a factor, the eye protection you need is available.

[Comprehensive Catalogue's Available on Request](#)



Euro Style Safety Spectacles

Sporty Style Safety Spectacles

Clear	200305	Green	200315	Clear	200325	Green	200335
Grey	200310	Amber	200320	Grey	200330	Amber	200340



Face Shields

Facial injuries can be life-changing, and that's why face protection is vital in many industries.

Face Shield Complete	200345
Face Shield Head Band only	200350
Face Shield Brow Guard for Hard Hat	200355
Face Shield Visor only	200360

Order codes



Hard Hats

Head injuries are a serious risk on many job sites and can affect a worker's health in many ways.

Fully adjustable six point head gear
Available in most colours
SABS Approved

HEARING PROTECTION

A full range of hearing protection devices for professional industrial use. From ear plugs to industrial ear muffs, our products are designed to fit a wide range of applications.

[Comprehensive Catalogue's Available on Request](#)



Disposable ear plugs

Un-corded	200365
Corded	200370



Reusable ear plugs

Un-corded	200375
Corded	200380



Howard Leight Laser Lite®

Un-corded	200385
Corded	200390



Howard Leight Quite® QD 30

Un-corded	200395
Corded	200400



Uvex Whisper

Un-corded	200405
Corded	200410



FALL PREVENTION - SAFETY HARNESSSES

Falls are frequently the source of injuries on construction sites.

With the proper equipment your employees can go a long way toward reducing injuries from falls.

At **EVERLAST** You will find a huge selection of fall protection products. All Harnessed comes with test certificates



SKYRIDERS



MILLER

SpiderWebb



EHS



Gotcha

SABS

NOSA
★★★★



Single Lanyard
Double Lanyard
Kidney Belts
Miners Belts
Scaffold Hooks
Snap Hooks
Small to XXXL

WORKWEAR

Whatever the job requires, it's good to make sure that your employees have high quality protective clothing.

We Supply & Stock a Wide range of overalls to suit your Needs.

We have all types & fabrics of Overalls to suit any Condition and Enviroment.

Our Overalls Range is used in construction, mining, automotive, engineering, food industries & mechanical.



Basic Royal Blue Conti
2pc Poly Cotton
Sizes from 34 - 54
Available in most colours



J54 100% Cotton
2pc Heavy Duty
Sizes from 34 - 54
Made to SABS spec



Flame Retardant Conti
Triple Stitching in Seams
D59 material 100% cotton
Sizes from 34 - 54



Boiler Suit
Avail. in Poly cotton & J54
Available in most colours
Concealed press studs



Denim 2pc Conti
Heavy duty
Large front pockets
Sizes from 34 - 54



Sasol Spec Zero Flame
Heavy Duty D59 material
Made to SABS spec
Flame Retardant
Reflective tape arm & legs



Reflective Jackets
Sizes from small to XXXL
Made with ZIP & I.D pocket
Lime & Orange
Also avail. In Bib style



We add Reflective tape to conti according to your request & Embroidery, screen printing services

WELDING EQUIPMENT

TIG TORCHES AND SPARES

EVERLAST Welding Torches incorporate high quality and technology needed for trouble-free performance whatever the welding job. Our TIG torches and accessories are engineered using high-quality materials, durable components and innovative designs to optimize your TIG welding performance.



TIG Torch Packages
 17V Torch 150Amp 4m - 400020
 17V Torch 150Amp 8m - 400025
 26V Torch 200Amp 4m - 400030
 26V Torch 200Amp 8m - 400035

ALSO IN HIGH FREQUENCY START

TIG Torches can be custom built to customer requirements !!



TIG Torch Components

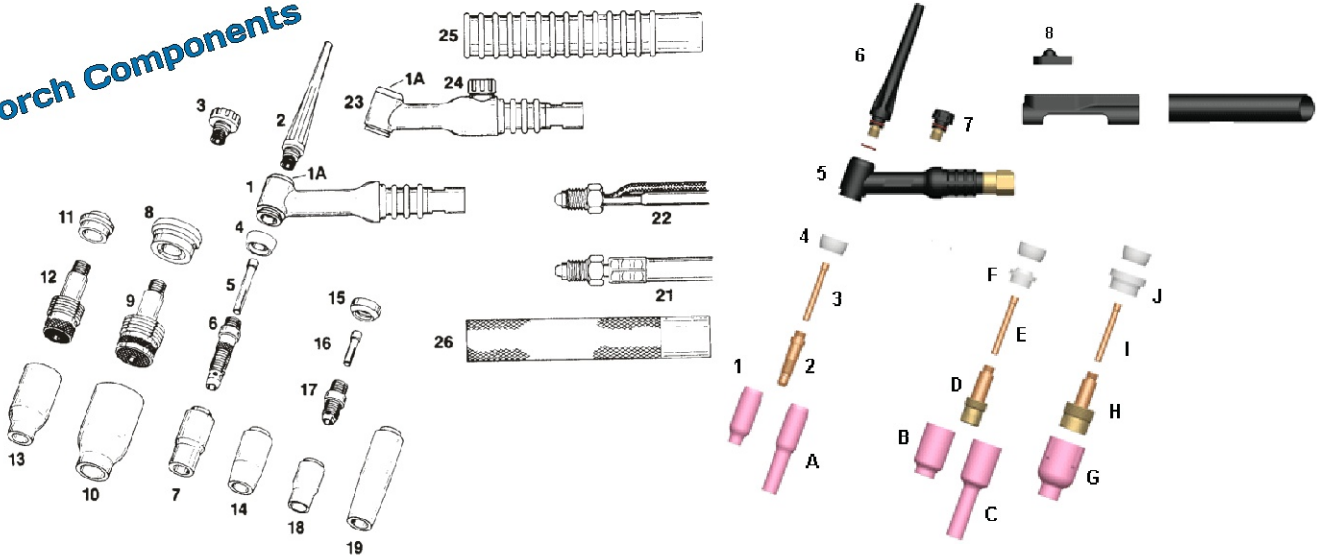

TIG Fittings



Argon Flowmeter
MIG & TIG Applications



Y-Piece



H.F. Switch



Switch Boot



Oetiker Clips



Nut, Nipple & Tail Piece



Adaptor blocks



Dissolving Purge
paper & Tape

Paper
400mmx50M
800mmx50M

Tape
25mm x 90M
50mm x 90M

TIG Tungsten Electrodes
ANSI / AWS A5.12M-98
1.6 X 150 400015
2.4 X 150 400010



Argon Gas Hose



Braided Hose 4mm
Inert Gas Hose 4mm

Pickling Paste

Pickling pastes remove annealing colours, welding scale and corrosion products in the area of welding and heat affected zones of stainless steel materials.

Available in Pickling paste & Spray
Cleaning & Maintenance, Degreasers
and Passivation Products



Contact your rep for detailed information and specs !!

ARC WELDING EQUIPMENT



Optimus Elec Holder
300A - 300105
400A - 300110
600A - 300115



Jaw Type Elec Holder
300A - 300120
500A - 300125



Twist Lock Elec Holder
400A - 300130
600A - 300135



Crocodile Earth Clamp
300A - 300140
400A - 300145
600A - 300150



Brass G Type Clamp
600A - 300155



Welder Wire Brush
Mild Steel - 300160
Stainless Steel - 300165



Welders Chipping Hammer With Spring Handle
300170



Cable Connectors
10-25 Male 10-25 Female
35-50 Male 35-50 Female
50-70 Male 50-70 Female



Temperature Indication Sticks
Available from 38°C to 600°C



Auto-Darkening Solar Powered Lens
Shade control 9 - 13
300205

Standard Flip Front Welding Helmets
300210



Welding Cables
16mm² - 120mm²



Welding Blanket
2m x 2m 300215
1m x 50m ROLL 300220
Welding Blankets Custom Made To any Size



Welding Cable Sets
16mm x 4m set 300225
25mm x 4m set 300230
35mm x 4m set 300235



Welding Cable Lugs
16x12 300240 35x12 300250
25x12 300245 50x12 300255

Welding Screens
For a Safer Working Environment



2m x 2m 300280
3m x 3m 300285
Welding Screen Custom Made To any Size

Welding Baking Oven 55lt 300290
Welding Holding Oven 55lt 300295

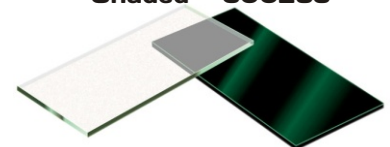

Welding Lens
Clear 300260
Shaded 300265

Welding Hot Box
10kg 300300



GAS CUTTING EQUIPMENT

 Gas Cutting Torch Universal 600105	 Cutting Attachment 600110	 Shank / Handle 600115	 Mixer 600120	 Cutting Nozzles
				ANM 600125 PNM 600130 2890 600135
 Gas Regulator Acetylene 600140	 Gas Regulator Oxygen 600145	 Gas Regulator LPG 600150	 Regulator Acetylene 600155	 Regulator Oxygen 600160
			Torch Acetylene 600165	Torch Oxygen 600170
 Gas Hose	 Flint Lighter 600185	 Nozzle Cleaner 600190	 Gas Fittings	 Gas Trolley
Oxygen 600175 Acetylene 600180			Oxy Nut 600195 Acey Nut 600200 Tail Piece 600205	 Flash Back Arrestors
			Single 600210 Double 600215	 Welding & cutting Outfit H/D 600220

MIG EQUIPMENT

EVERLAST MIG Torch's combines quality, Design and Performance to ensure optimum hassle free operation. Choosing the right tool for the job is important! Our offering of industrial MIG welding guns is designed specifically to accommodate a variety of welding styles, preferences and applications.



BZ15 X 4M	700105
BZ25 X 4M	700110
BZ36 X 4M	700115
BZ40 X 4M	700120
Bz501 X 4M	700125





MIG Nozzles / Shrouds

Bz15	700130
BZ25	700135
BZ36	700140
BZ40	700145
Bz501	700150

MIG Contact Tip

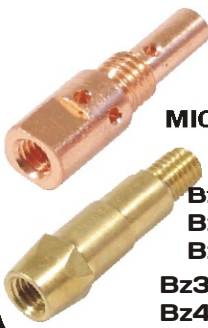
M6 x 0.9mm	700155	M8 x 0.9mm	700170
M6 x 1.0mm	700160	M8 x 1.0mm	700175
M6 x 1.2mm	700165	M8 x 1.2mm	700180

Torches can be custom built to customer requirements !!

 MIG Tip Adaptors	 Swan Neck	 Gas Diffuser	 Torch Handle 700255
Bz15 x M6 700185 Bz25 x M6 700190 Bz36 x M6 700195 Bz36 x M8 700200 Bz40 x M8 700205 Bz501 x M8 700210	Bz15 700215 BZ25 700220 BZ36 700225	Bz36 700240 Bz40 700245 Bz501 700250	
	BZ40 700230 Bz501 700235		 Torch Liner
			Bz15 700260 BZ25 700265 BZ36 700270 BZ40 700275 Bz501 700280

INDUSTRIAL WELDING MACHINES

Compact Welding Inverter for MMA & lift TIG
Digital Display
60% Duty Cycle
Includes Accessories

160 amp
800105

200 amp
800110

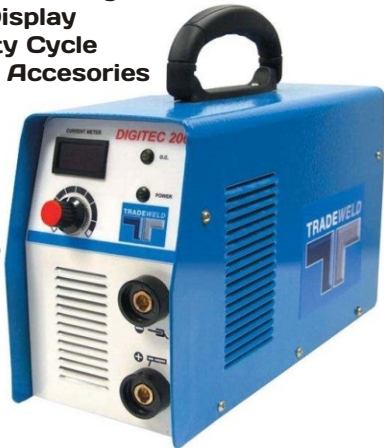

Esab Inverter for MMA and TIG with LiveTig™ start.
Easy to operate with Digital display.
Adjustable Hot start & Arc force.

200 amp
800130



IGBT Inverter
Easy Ignition & Smooth Welding
Scratch start TIG function
Digital Amp meter

400 amp
800115

500 amp
800120

600 amp
800125



AC/DC TIG Welder
TIG & MMA welding of Mild Steel
Stainless Steel, Aluminum, Copper
Brass & Titanium 800145
HF Controls

ESAB Advanced TIG Welder
HF Start - Pulsed Welding
Adjustable Slope Features
Gas Flow Control
CADDY TIG 2200i
Ta33
800135



High Frequency TIG welder
Excellent Welding Characteristics
With TIG Torch
MMA Cables
200A 800140



MIG Welder Compact
Two Speed drive Wirefeeder
200amp 220v
Built in Wire Feeder 0.6 - 1mm wire

200 amp
800150

250 amp
800155



Plasma Cutter
Industrial HF Start
Cuts most Metals
220 - 380v
40A 800180
60A 800185
100A 800190
160A 800195



MIG Welder Heavy Duty
Separate Wire Feeder
Transformer Technology
Four Wheel drive Wirefeeder System
Built in Wire Feeder 1mm - 1.6mm wire
Complete with MIG Torch 380V - 525V
350amp 800160
500amp 800165
500amp 380/525V 800170



Multi Process Welder
STICK MIG TIG
Three Welding Processes
220v 250Amp
IGBT Technology

800175



TUNGSTEN CARBIDE BURRS

EVERLAST TC Burrs are manufactured from high grade tungsten carbide which insures long life and durability.



CYLINDRICAL END CUT B

B102006
B122506



CYLINDRICAL BALL NOSE C

C102006
C122506



BALL SHAPE D

D100906
D121006



ROUND TREE F

F102006
F122506



POINTED TREE G

G102006
G122506



CONICAL M

M102006
M122506



PODGER SPANNERS

10 X 13	900165	24 X 30	900180
17 X 19	900170	32 X 36	900185
19 X 24	900175	41 X 46	900190



TAPER BRIDGE REAMER

16mm	900195	26mm	900215
18mm	900200	28mm	900220
22mm	900205	30mm	900225
24mm	900210	32mm	900230



FLAP WHEELS

30x25	500060	63x25	500150
38x25	500115	75x25	500205
50x25	500010		



FLAP DISCS

115mm Alu Oxide 500235
115mm Zirconia 500225



BOILERMAKERS CHALK BOX 144 300305



WELDING CONSUMABLES

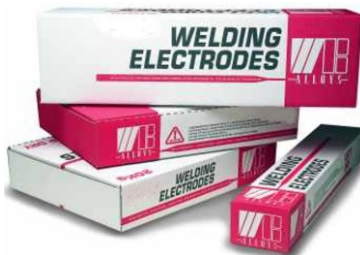

GENERAL PURPOSE ELECTRODES E6013

2.50mm 110105
3.15mm 110110
4.0mm 110115



GENERAL PURPOSE MIG WIRE ER70S-6

0.9mm 110120
1.2mm 110125



TIG WIRE ER70S-6

1.6mm 110130
2.0mm 110135
2.4mm 110140



ESAB MILD STEEL ELECTRODES E6013

2.50mm 110145
3.20mm 110150
4.0mm 110155



ESAB MILD STEEL MIG WIRE ER70S-6

0.9mm 110160
1.2mm 110165

ESAB TIG WIRE ER70S-6

1.6mm 110170
2.0mm 110175
2.4mm 110180



PFERD ABRASIVES



PFERD CUTTING DISC MILD STEEL
4.5" 115-2.4mm - ETH115-2.4 A30 SG
6" 150-3.0mm - EHT150-3.0 A24 SG
9" 230-3.0 - EHT230-3.0 A24 PSF



PFERD CUTTING DISC INOX S/S
4.5" 115-2.4mm - ETH115-2.4 A46 SG INOX
6" 150-2.5mm - EHT150-2.5 A24 SG INOX
9" 230-3.2 - EHT230-3.0 A24 SG INOX



PFERD GRINDING DISC MILD STEEL
4.5" 115-6mm - E115-6 A30 PSF
6" 150-7mm - E150-7 A24 SG
9" 230-7 - E230-7 A30 PSF



PFERD GRINDING DISC INOX S/S
4.5" 115-5mm - E115-5 A30 SG INOX
6" 150-7mm - E150-7 A30 SG INOX
9" 230-7 - E230-7 A30 PSF INOX



PFERD CUT-OFF WHEELS
350mm - 80T350-2.8 A36 SG CHOP
400mm - 80T400-3.2 A36 SG CHOP
450mm - 80T450-5.0 C24 SG UNI

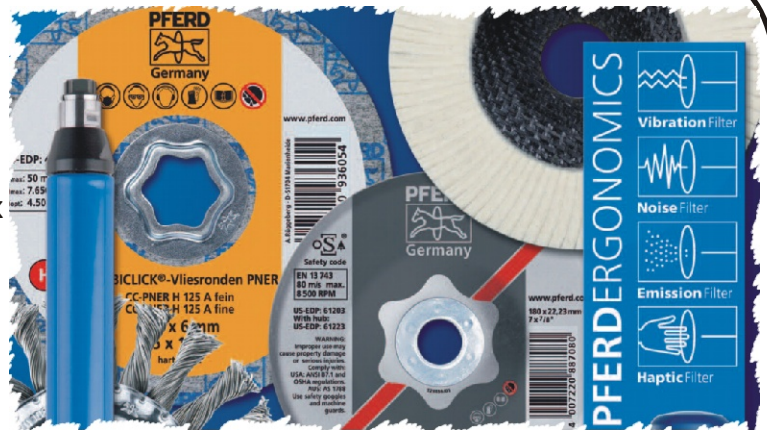

PFERD FIBRE DISC
100mm - FS100-16 A GRIT
115mm - FS115-22 A GRIT
125mm - FS125-22 A GRIT
180mm - FS180-22 A GRIT



PFERD WIRE CUP BRUSHES
60mm - TBU60/M14 ST
75MM - TBU75/M14 ST
100mm - TBU100/M14 ST

Also Distributors of      

MAGNETIC BASE DRILLS



EVERLAST
INDUSTRIAL PRODUCTS
MAG BASE DRILL
35mm Cutter
1200W 120105



EVOLUTION
MAG BASE DRILL
35mm Cutter
1200W 120110



HITACHI
POWER TOOLS
MAG BASE DRILL
35mm Cutter
720W 120115



metabo
work. don't play.
MAG BASE DRILL
35mm Cutter
720W 120120



EUROBOOR
MAG BASE DRILL
100mm Cutter
32mm MT
1800W 120125

JANCY
MAG BASE DRILL
100mm Cutter
32mm MT
1800W 120130



MAGTRON
HOLE CUTTING TECHNOLOGY
MAG BASE DRILL
100mm Cutter
32mm MT
1800W 120135

We Carry a Full Range Of Slugger Cutters, Pilot Pins, Countersinks, Chuck Adaptors Arbors, Sleeves & Morse Taper Drills

Our Slugger Cutters are Available in HSS, TCT & Co8e Long & Short Series



INDUSTRIAL POWER TOOLS



METABO
115mm Grinder
W720 - 720watt
W8-115 - 850watt
W1080 - 1080watt



BOSCH
115mm Grinder
GWS7-115 - 720watt
GWS850C - 850watt
GWS9-115 - 900watt



HITACHI
115mm Grinder
G12SS - 580watt
G12S2 - 760watt
G12SE2 - 1200watt



DEWALT
115mm Grinder
DW818 - 800watt
D28113 - 900watt
D28143 - 1100watt



MAKITA
115mm Grinder
9554 - 710watt
9557 - 840watt
9564 - 1100watt



METABO
125mm Grinder
W11-125 - 1100watt
WE1450-125 - 1450watt
W14-125 - 1400watt



BOSCH
125mm Grinder
GWS10-125Z - 1000watt
GWS11-125 - 1100watt
GWS14-125 - 1400watt



HITACHI
125mm Grinder
GWS10-125Z - 1000watt
GWS11-125 - 1100watt
GWS14-125 - 1400watt



DEWALT
125mm Grinder
D28130 - 900watt
DW831 - 1400watt
D28136 - 1500watt



METABO
230mm Grinder
W2000 - 2000watt
W24-230 - 2400watt
W26-230 - 2600watt



BOSCH
230mm Grinder
GWS24-230 - 2400w
GWS26-230 - 2600w



HITACHI
230mm Grinder
G23SS - 2200w
G23MR - 2500w



DEWALT
230mm Grinder
D28414 - 2200w
D28432 - 2600w



MAKITA
230mm Grinder
Ga9020 - 2200w
GA9040 - 2600w



METABO
CUT-OFF SAW
CS23-355
2300w



BOSCH
CUT-OFF SAW
GC02000
2000w



RYOBI
CUT-OFF SAW
C3560
2100w



MAKITA
CUT-OFF SAW
2414NB
2000w



METABO
DIE GRINDER
GE710C - 710watt Short
GE710P - 710watt Long
GE710P - 950watt Long



BOSCH
DIE GRINDER
GG28C - 650W Short
GG28LC - 650W Long



HITACHI
DIE GRINDER
GP2 - 520W Long



MAKITA
DIE GRINDER
GD0600 - 400w Short
GD0800C - 750w Long

POWER TOOLS



METABO
Impact Drills
SBE561 - 560w
SBE710 - 710w
SBE1100 - 1100w



BOSCH
Impact Drills
GSB16RE - 700w
GSB19-2RE - 850w
GSB21-2RE - 1100w



HITACHI
Impact Drills
DV13SS - 550w
DV18V - 690w
DV20VB2 - 790w



DEWALT
Impact Drill
DWD024 - 650w
D21710 - 701w
D21805 - 770w



MAKITA
Impact Drill
HP1640 - 680w
HP2050 - 720w
HP2070 - 1010w



METABO
Rotary Hammer
BHE2243 - 800w
KHE2850 - 1010w
KHE56 - 1300w



BOSCH
Rotary Hammer
GBH2-23RE - 650W
GBH5-38D - 1050w
GBH7-46DE - 1350W



HITACHI
Rotary Hammer
DH22PG - 620w
DH28PC - 720w
DH45MR - 1200w



DEWALT
Rotary Hammer
D25012K - 650w
D25313K - 800w
D25404K - 900w



MAKITA
Rotary Hammer
Hr2230 - 710w
HR3200 - 850w
HR5211 - 1500w



BOSCH
Demolition Hammer
GSH16-28 - 1750w
GSH27VC - 2000w



HITACHI
Demolition Hammer
H65MR - 1300w
H65SC - 1240w
H70SA - 1240w



DEWALT
Demolition Hammer
D25899 - 1500w
D25901 - 1500w
D25941 - 1600w



MAKITA
Demolition Hammer
HM1203 - 1510w
HM1307 - 1510w
HM1801 - 2000w

BOSCH
Sabre Saw
GFZ16-35 - 1600w
GSA1200 - 1200w



METABO
Sabre Saw
PSE1200 - 1200w



HITACHI
Impact Wrench
WR16SA - 480w 1/2"
WR22SA - 3/4"



DEWALT
Impact Wrench
DW292 - 710w 1/2"
DW294 - 710w 3/4"



MAKITA
Impact Wrench
TW0200 - 380w 1/2"
6906 - 710w 3/4"
TW1000 - 1300w 1"



BOSCH
Impact Wrench
GDS18E - 500w 1/2"
GDS24 - 800w 3/4"
GDS30 - 920w 1"



Contact US
AR INDUSTRIAL
10b OHM INDUSTRIAL PARK,
OHM STREET, KYA SANDS, RANDBURG
JOHANNESBURG, SOUTH AFRICA

Tel: +27 11 708 6392
Fax: +27 11 708 6391

info@arindustrial.co.za
www.arindustrial.co.za
www.arindustrialcatalogue.co.za

BRANDS WE OFFER:

